

QST

DEVOTED ENTIRELY TO

AMATEUR RADIO

PUBLISHED SINCE 1915 BY THE AMERICAN RADIO RELAY LEAGUE INC.



FEBRUARY

1929

25¢

Just Out—
The New Fourth Edition of

The Radio Amateur's Handbook

By HANDY and HULL

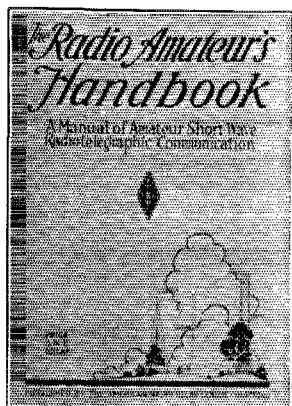

FOR THOSE WHO DON'T KNOW IT:

The Handbook is a practical manual of amateur radio in all its phases, published by the American Radio Relay League, the amateur's own organization. It starts at the beginning and tells the whole story: What amateur radio is, How to be a radio amateur, How to obtain your licenses, How to build the simple apparatus of a simple station, How to build the best known apparatus for the most modern station, How to operate the station. Enough information to keep you busy and interested for five years.

FOR THOSE WHO DO KNOW IT:

For years the Handbook has been the practical working guide of successful amateurs the world over. Now it has been completely revised in terms of 1929, by Mr. Handy, the League's Communication Manager, as to all the aspects of operating procedure, and by Mr. Hull, the director of the League's current Technical Development Program, as to all its features of apparatus and technical matters. Everything in it is on a 1929 basis, replacing the 1928 methods which used to be good enough but aren't any more.

MUCH THAT IS NEW—ALL THAT IS GOOD

Like QST, "Devoted Entirely to Amateur Radio"

Now in its 43d thousand

240 pages, 6½ x 9½, 188 illustrations

In wealth of treatment and profusity of illustration the Handbook is a big book. Printed in usual textbook style it would bulk 500 pages and cost at least \$4, but its publication in the familiar QST format makes for handiness and enables its distribution at very modest cost.

\$1.00 POSTPAID ANYWHERE IN THE WORLD

**CLIP A DOLLAR BILL TO YOUR NAME AND ADDRESS
WE'LL KNOW WHAT YOU WANT**

American Radio Relay League, Hartford, Conn., U.S.A.

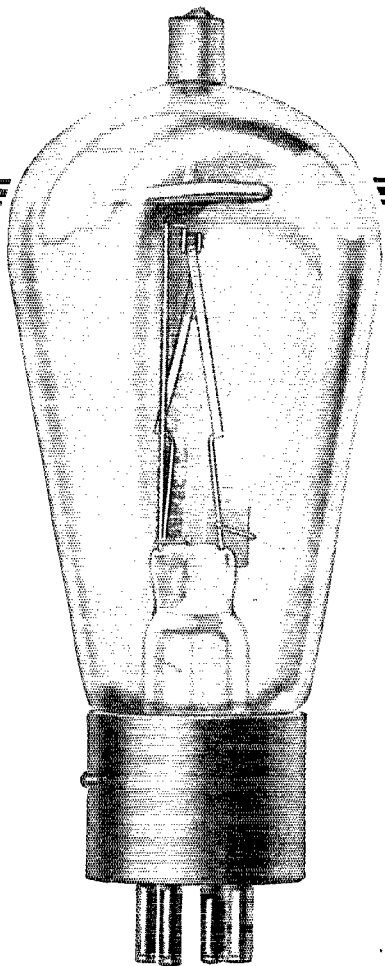

RCA ANNOUNCES RADIOTRON UX-866

A sturdy rectifier with a low and constant voltage drop.

This is RCA's latest contribution to Amateur Radio. A hot-cathode, mercury vapor rectifier, that establishes a new standard of performance for the amateur transmitter operating with rectified plate supply.

Ample in current capacity, and possessing a low and constant internal voltage drop, Radiotron UX-866 in half or full-wave circuit connections, is especially suited for supplying the transmitter with stable rectified plate voltage,—key up or key down.

The rugged construction of Radiotron UX-866, the relatively low temperature at which it operates, the fact that no starting mechanism is required,—all these are factors insuring satisfactory operation.

If your dealer cannot supply you, the nearest RCA District Office listed below will be glad to send you Radiotron UX-866 postpaid, on receipt of money order and call letters of your station.

<i>Filament Volts</i>	2.5
<i>Filament Amperes</i>	5.0
<i>Max. Peak Inverse Volts</i>	5000
<i>Max. Peak Plate Amperes</i>	9.6
<i>Approx. Tube Voltage Drop (Volts)</i>	15
<i>Max. Overall Length</i>	6-5/8"
<i>Max. Overall Diameter</i>	2-7/16"
<i>List Price</i>	\$12.50

RADIO CORPORATION OF AMERICA

100 West Monroe Street
Chicago, Ill.

Santa Fe Bldg., Unit No. 1
Dallas, Texas.

233 Broadway
New York City

235 Montgomery Street
San Francisco, Cal.

101 Marietta Street
Atlanta, Ga.

*Taper
Plate
Cardwell
Type 191E
Ideal For Short Wave Receivers*

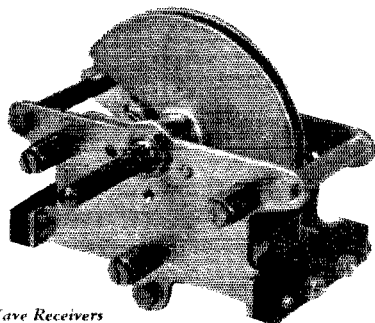

"The Best is The Cheapest"

—Benjamin Franklin

THE nearest Ben ever came to anything even remotely connected with Radio was when he flew his kite and drew sparks of static electricity from his kite string.

The simple appurtenances of his day have been multiplied a thousand times but the same old adage still holds good, right down to condensers.

Extra pennies invested in the best obtainable condensers pay handsome dividends and using second rate condensers is poor economy.

Cardwell Taper Plate Condensers are sturdy, vibrationless, hold their calibration indefinitely and the purchase price includes satisfaction insurance.

Good enough for the biggest of the big boys—fellows like the G. E., R. C. A., and Uncle Sam, and if they don't know who does? Gold plates and funny jim-cracks may look impressive, but they don't influence the fellows WHO KNOW THEIR CONDENSERS.

CARDWELL CONDENSERS
TRANSMITTING * RECEIVING
FIXED AND VARIABLE

"THE STANDARD OF COMPARISON"

Cardwell Taper Plate Condensers are made in five capacities—.000075 to .0005.

All good dealers have Cardwells.

If you want them and your Dealer doesn't stock them, send direct to us.

Literature is yours for the asking.

The Allen D. Cardwell Mfg. Corp.
81 PROSPECT STREET
BROOKLYN, N. Y.

Section Communications Managers of THE COMMUNICATIONS DEPARTMENT, A. R. R. L.

Eastern Pennsylvania W3QP
Maryland-Delaware-District of Columbia W3AFS
Southern New Jersey W3CFG
Western New York W3PFI
Western Pennsylvania W8CFE

Illinois W9APY
Indiana W9CYQ
Kentucky W9RAJ
Michigan W8CFE
Ohio W8HYN
Wisconsin W9VD

North Dakota W9DYV
South Dakota W9DGR
North Minnesota W9WVH
South Minnesota W9EYK

Arkansas W5ABI
Louisiana W5BBI
Mississippi W5AKP
Tennessee W4E1

Eastern New York W2CNS
N. Y. C. & Long Island W2KR
North New Jersey W2WR

Iowa W9DZAV
Kansas W9CET
Missouri W9HR
Nebraska W9BYG

Connecticut W1ZL
Maine W1BIG
Eastern Massachusetts W1UE
Western Massachusetts W1UM
New Hampshire W1ATI
Rhode Island W1FCR
Vermont W1IT

Alaska WWDN
Idaho W7ACN-77L
Montana W7AAT-74F
Oregon W7PP
Washington W7FD

Hawaii K6CFQ
Nevada W7HO
Los Angeles W8AM
Santa Clara Valley W8NX
East Bay W8CZR
San Francisco W8WB
Sacramento Valley W8CBS
Arizona W8ANO
Philippines* op1AT
San Diego W8GQ

North Carolina W4SJ
Virginia W8CA
West Virginia W8VZ

Colorado W9CAA
Utah-Wyoming W8BAJ

Alabama W4AAQ
Florida* W4HY
Georgia-So. Carolina-Cuba-Porto Rico-Isle of Pine W4KU

New Mexico W5AKN
Northern Texas W5AMO
Oklahoma W5OX
Southern Texas W5TT

Newfoundland VE8AR
New Brunswick VE1ET
Nova Scotia VE1DQ
Prince Edward Island VE1BZ

Ontario VE8FC

Quebec VE2BE

Alberta VE4HA
British Columbia VE5BJ

Manitoba VE6VF
Saskatchewan VE1FC

ATLANTIC DIVISION

J. B. Morgan, 2nd 381 E. Willow Grove Ave. Chestnut Hill, Phila.
Dr. H. H. Layton 805 Washington St. Wilmington, Del.
M. J. Lottsh Box 49, RFD 1 Cranbury, N. J.
C. S. Taylor 598 Masten St. Buffalo, N. Y.
A. W. McAuliy 309 Third St. Oronout

CENTRAL DIVISION

Fred J. Hinds 2387 Oak Park Blvd. Berwyn
D. J. Angus 210 N. Illinois St. Indianapolis
J. B. Wathen, III Box 97, R. F. D. 1 Louisville
Dallas Wise 9187 Falcon Ave. Detroit
H. C. Storck 694 Carpenter St. Columbus
C. N. Crapo 443 Newton Ave. Milwaukee

DAKOTA DIVISION

B. S. Warner 309 4th Ave. Enderlin
D. M. Fasek 730 Illinois St. Huron
Carl L. Jabs 1822 James St. St. Paul
J. C. Fehoushek 130 Warwick St., S. W. Minneapolis

DELTA DIVISION

H. E. Vette 5408 U St. Little Rock
M. M. Hill Oakdale
J. W. Gullett Meridian
Polk Purdue 1708 23rd Ave. Nashville
7/0 Radio Station WBAW Nashville

HUDSON DIVISION

F. M. Holbrook 5 Livingston Ave. White Plains
M. R. Kahn 617 W. 141st St. N. Y. C.
A. G. Wester, Jr. 50 Princeton St. Maplewood

MIDWEST DIVISION

H. W. Kerr Little Sioux
J. H. Amis Toneska
L. B. Lalzure 8010 Mercer St. Kansas City
C. B. Delhi 5605 Cedar St. Omaha

NEW ENGLAND DIVISION

C. A. Weldenhammer 33 Washington Place Bridgeport
Frederick Best 13 E. Crescent St. Augusta
E. L. Battey 29 Royal St. Wollaston
Dr. John A. Tessmer, S. Schaffner St. Worcester
V. W. Hodges 227 Main St. Claremont
C. N. Kraus 92 Keene St. Providence
Elaston Paulette North Troy

NORTHWESTERN DIVISION

W. B. Wilson 17 S. LHT Fern Ketchikan
James L. Young 303 13th Ave. So. Nampa
C. W. Viers Red Lodge
R. H. Wright 310 Ross St. Portland
Otto Johnson 2340 30th Ave. W. Seattle

PACIFIC DIVISION

F. L. Fullaway 2714 Manoa Rd. Honolulu
C. B. Newcombe Yecington
D. C. Wallace 209 Pine Ave., Room 410 Long Beach Calif.
F. J. Quement 252 Hanchett Ave. San Jose
J. Walter Frates 368 62nd St. Oakland
C. E. Bates 202 Castro St. San Francisco
C. F. Mason 2530 N. St. Sacramento
D. H. Lamb 229 W. First St. Mesa
M. I. Felizardo 272 Galipia St. Manila
G. A. Sears 238 Bonair St. La Jolla

ROANOKE DIVISION

Enno Schuelke R. F. D. No. 1 Ridgeway
J. F. Wohlford 118 Cambridge Ave. Roanoke
F. D. Reynolds 1680 3rd Ave. Huntington

ROCKY MOUNTAIN DIVISION

C. R. Stedman 1641 Albion St. Denver
Parley N. James 439 "D" St., Salt Lake City

SOUTHEASTERN DIVISION

S. J. Bayne 9 Park Ave. Montgomery
E. M. Winter 214 Rosedale St. Jacksonville
H. L. Reid 11 Shadowlawn Ave. Atlanta

WEST GULF DIVISION

J. H. Robinson, Jr. 522 Cumberland St. Dallas
Glenn Morgan 763 Asp Ave. Norman
R. E. Franklin 1806 Valentine St. Houston
L. E. Radka Tucumcari

MARITIME DIVISION

Loyal Reid Avalon House St. Johns
T. E. Lacey 520 N. B. Power Co. St. John
A. M. Crowell 59 Dublin St. Halifax
F. W. Hyndman 25 Fitzroy St. Charlottetown, P. E. I.

ONTARIO DIVISION

E. C. Thompson 256 Queensdale Ave. Toronto, 6

QUEBEC DIVISION

Alex Reid 169 Logan Ave. St. Lambert

VANALTA DIVISION

E. J. Taylor 10107-87th Ave. Edmonton
E. S. Brooks 2987 Camosun St. Vancouver

PRAIRIE DIVISION

D. B. Sinclair 295 Cambridge St. Winnipeg
W. J. Pickering 514 19th St. W. Prince Albert

*Temporary officials appointed to act until the membership of the Section concerned choose permanent SCMS by re-nomination and election.

Q R H

General Radio Company

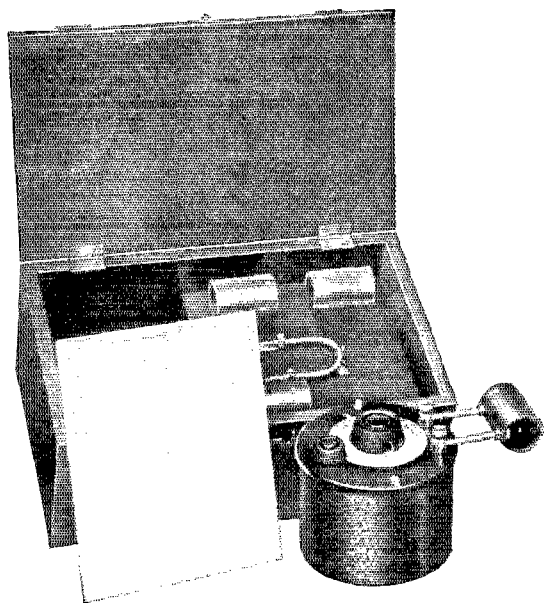

Type 558 Amateur Band Frequency Meter
Price - - \$20.00

Bulletin No. 931
describing our complete line of
Radio Apparatus

will be sent on request

GENERAL RADIO CO.

30 STATE STREET
274 BRANNAN STREET

CAMBRIDGE, MASS.
SAN FRANCISCO, CALIF.

IN THE TYPE 558 Amateur-Band Frequency Meter a fixed air condenser is connected in parallel with the variable condenser. This arrangement spreads a narrow band of frequencies over the entire wavemeter scale which greatly increases the accuracy of reading. Five coils are used, covering the following amateur bands:

Coil A.....	56,000-60,000 Kc.
Coil B.....	28,000-32,000 Kc.
Coil C.....	14,000-16,000 Kc.
Coil D.....	7,000- 8,000 Kc.
Coil E.....	3,500- 4,000 Kc.

The accuracy of calibration is to within 0.25%. When it is considered that this is the same precision as is guaranteed for the Type 224 Precision Wavemeter which sells at \$190.00, the low price of this instrument is particularly striking.

A wooden case with a mounting rack for the coils and for the condenser is supplied with each wavemeter.



QST



The Official Organ of the A.R.R.L.

VOLUME XIII

FEBRUARY, 1929

NUMBER 2

	PAGE
Editorials	7
Official Frequency Stations	8
The Requirements of Transmitter Keying <i>Ross A. Hull</i>	9
Standard Frequency Transmissions from W9XL	19
A New Type of Rectifier Tube for Amateur Use <i>D. W. Pike and H. T. Maser</i>	20
An Examination of A.C. Plate Supply <i>Ross A. Hull</i>	23
Coming! Governors-President Relay	28
A "1929" Receiver <i>Paul S. Hendricks</i>	29
Let's Get Serious <i>Joe Gish</i>	33
Silent Keys	33
A Cheap Radio Frequency Meter <i>George W. Woster</i>	34
The Design of Inductance Coils <i>D. R. Clemons</i>	35
The UV-861 <i>Harold P. Westman</i>	41
The UV-861 in Action <i>Clark C. Godimon</i>	44
A Multi-Range Voltmeter <i>Harold P. Westman</i>	49
Experimenters' Section	51
I.A.R.U. News	52
Calls Heard	58
Correspondence Department	54
Technical Information Service Rules	76
Hamads and QRAs	91
QST Index of Advertisers	94

QST is published monthly by The American Radio Relay League, Inc., at Hartford, Conn., U. S. A. Official Organ of the A.R.R.L. and the International Amateur Radio Union

Kenneth B. Warner (Secretary, A.R.R.L.),
Editor-in-Chief and Business Manager

F. Cheyney Beekley,
Managing Editor and Advertising Manager

Harold P. Westman,
Technical Editor

Ross A. Hull,
Associate Technical Editor

David H. Houghton,
Circulation Manager

Subscription rate in United States and Possessions, Canada, and all countries in the American Postal Union, \$2.50 per year, postpaid. Single copies, 25 cents. Foreign countries not in American Postal Union, \$3.00 per year, postpaid. Remittances should be by international postal or express money order or bank draft negotiable in the U. S. and for an equivalent amount in U. S. funds.

Entered as second-class matter May 29, 1919, at the post office at Hartford, Connecticut, under the act of March 3, 1879. Acceptance for mailing at special rate of postage provided for in section 1103, Act of October 3, 1917, authorized September 9, 1922. Additional entry as second-class matter, acceptable at special rate of postage provided for above, at Springfield, Mass., authorized September 17, 1924.

Copyright 1929 by the American Radio Relay League, Inc. Title registered at United States Patent Office. Member of the Radio Magazine Publishers' Association.

The American Radio Relay League

The American Radio Relay League, Inc., is a non-commercial association of radio amateurs, bonded for the promotion of interest in amateur radio communication and experimentation, for the relaying of messages by radio, for the advancement of the radio art and of the public welfare, for the representation of the radio amateur in legislative matters, and for the maintenance of fraternalism and a high standard of conduct.

It is an incorporated association without capital stock, chartered under the laws of Connecticut. Its affairs are governed by a Board of Directors, elected every two years by the general membership. The officers are elected or appointed by the Directors. The League is non-commercial and no one commercially engaged in the manufacture, sale or rental of radio apparatus is eligible to membership on its board.

"Of, by and for the amateur", it numbers within its ranks practically every worth-while amateur in the world and has a history of glorious achievement as the standard-bearer in amateur affairs.

Inquiries regarding membership are solicited. A bona fide interest in amateur radio is the only essential qualification; ownership of a transmitting station and knowledge of the code are not prerequisites. Correspondence should be addressed to the Secretary.

DIRECTORS

President
HIRAM PERCY MAXIM
Drawer 2102,
Hartford, Conn.

Vice-President
CHARLES H. STEWART
St. David's, Pa.

Canadian General Manager
A. H. E. RUSSELL
5 Mail Bldg.,
Toronto, Ont.

Atlantic Division
DR. EUGENE C. WOODRUFF
234 W. Fairmount Ave.,
State College, Pa.

Central Division
CLYDE E. DARR
187 Hill Ave., Highland Park,
Detroit, Mich.

Dakota Division
C. M. JANSKY, JR.
Dept. of Elec. Eng., U. of M.
Minneapolis, Minn.

Delta Division
BENJ. F. PAINTER
424 Hamilton Nat'l Bank Bldg.
Chattanooga, Tenn.

Hudson Division
DR. A. LAFAYETTE WALSH
220 West 42d St.,
New York City

Midwest Division
PORTER H. QUINBY
817 Lauderman Building,
St. Louis, Mo.

New England Division
FREDERICK BEST
13 East Crescent St.,
Augusta, Maine

Northwestern Division
R. W. WEINGARTEN
3219 No. 24th St.,
Tacoma, Wash.

Pacific Division
ALLEN H. BABCOCK
55 Market St.,
Southern Pacific Co.,
San Francisco

Roanoke Division
W. TREDWAY GRAVELY
Box 245,
Danville, Va.

Rocky Mountain Division
PAUL M. SEGAL
Box 1771
Denver, Colo.

Southeastern Division
HARRY F. DOBBS
c/o Dobbs & Wey Co.,
245 Spring St., N. W.,
Atlanta, Ga.

West Gulf Division
FRANK M. CORLETT
2515 Catherine St.,
Dallas, Tex.

OFFICERS

President HIRAM PERCY MAXIM, Hartford, Conn
Vice-President CHARLES H. STEWART, St. David's, Pa.
Secretary KENNETH B. WARNER, Hartford, Conn.
Treasurer ARTHUR A. HEBERT, Hartford, Conn.
Communications Manager F. EDWARD HANDY, Hartford, Conn.

EDITORIALS

IN LATE December the Federal Radio Commission presented an expectant radio world with a Christmas package of large proportions in the form of the long-awaited decision respecting the so-called continental frequencies between 1500 and 6000 kc. Throughout 1928 a prodigious amount of study had been given these frequencies in Washington. Numerous hearings were held, thousands of applications were received and considered, several conferences were held with the other nations of North America, technical experts labored and reported at the request of the Commission, unreckonable testimony was taken. It has been a problem of great magnitude, next in importance only to the determination of policies with respect to broadcasting and the higher frequencies above 6000 kc. The Commission's decisions are of what is known as far-reaching importance, concerning many phases of which it is not our business to comment now. We amateurs have had a vital concern in the question, however, because included in this frequency range are the two amateur bands from 1715 to 2000 kc. and from 3500 to 4000 kc. In the international treaty signed at Washington in 1927 these two bands are internationally marked as shared between amateurs and the fixed and mobile services. This means that any government may make such sub-divisions of these bands as it wishes amongst these three services. In our country, of course, our government's representatives to the International Conference were willing to agree that these bands should be assigned to amateurs, except for the extent to which the last-named band is shared by Naval aircraft at sea by authority of the President.

Until the regulations in this frequency range were definitely announced by the Commission, however, the outcome had to be regarded as uncertain and there was much jockeying for position throughout the year on the part of various radio interests, including many people who could not understand why any such appreciable extent of radio territory was to be given to amateurs. Representatives of our A.R.R.L. were in attendance at Washington throughout last year when these questions were being considered, for we all know that that 3500- to 4000-kc. band is our life's blood now, the only place in the spectrum where we really have room enough to turn around in. There

is really a frightful amount of radio activity going on in Washington all of the time, and we wish that the members of the League could know how much of the unseen effort at Headquarters is expended in the constant effort to look after our affairs there. Much of it never gets reported in *QST* to the general membership, as generally it is not "news" unless there is some actual change in regulations.

In the present case, however, it is with real pleasure that we report that the Commission's announcements confirm the assignment to American amateurs of these two bands. Thus one long-awaited and important hurdle in our progress towards readjustment under the 1927 convention is safely topped.

We breathe more easily and look around us. We find the government radio department talking about us in their annual reports. The Federal Radio Commission's annual report to the Congress had the following to say about us:

"There are 16,926 amateur stations licensed. The radio division of the Department of Commerce has generously cooperated with the commission in the handling of amateur-station licenses.

"The international convention authorized each Government to assign certain frequency bands to amateur use. The Commission has followed the policy of authorizing amateur use of all such bands. The Commission has felt that the amateur has sufficiently demonstrated his usefulness, both in furthering the progress of the science of radio and in furnishing service in times of emergency, to justify a liberal policy with regard to his operation."

Amateur radio has grown in the past government fiscal year. The figure 16,926 represents an increase of 6.3 percent in the number of licensed amateur stations. Mr. Terrell, the Chief of the Radio Division of the Department of Commerce, in his annual report to the Secretary of Commerce, comments as follows about us in the portion of his report relating to amateurs:

"The amateur radio operators have received international recognition. At the International Radiotelegraph Conference, held in Washington October 4 to November 25, 1927, agreement was reached whereby the status of the amateur radio operator

was defined; his service as an experimenter and his value in promoting international good will recognized, and his continued activity assured by the allocation to him of certain specified wave lengths. This recognition was accomplished through the efforts of the delegations of Canada, Italy, Australia, New Zealand, and the United States. The new international treaty provides a new system of amateur calls to indicate nationality. The provisions of the new treaty become effective January 1, 1929.

"In September, 1927, at the request of the radio division, the American Radio Relay League made a survey to determine to what extent amateurs and former amateur radio operators are occupied in the radio industry. While it was impossible to get reports from all organizations employing men coming under this heading, the list furnished gives a fair idea of the extent to which the radio art and industry has recognized the value of amateur training and experience. Of those engaged in executive positions in the radio industry, the list shows 45 presidents, 16 vice presidents, 5 general managers, 69 managers, 37 owners, 324 engineers, 19 announcers, and 11 directors. This does not include those employed as operators."

Speaking of the International Conference he again mentions that:

"The conference gave definite recognition to the amateur in international radio com-

munication. The allocation to amateur service of four exclusive bands and two nonexclusive bands was secured through the efforts of the American delegation, with the support of the delegates from Canada, Australia, Italy, and New Zealand. The result is to give the amateurs much greater assurance of making contact with one another internationally."

We write in the early days of January. January 1st, another tremendous hurdle, has been safely crossed, and somewhat to the surprise of some of us we seem to be still alive and kicking. The air seems very much the same as it was before; in fact, too much so. There are no changes in amateur regulations except in the width of our bands, but every amateur knows that these widths were changed effective the first of the year. We cannot feel that there is excusable reason for an amateur operating outside the new frequency bands—our preparation for success within these limitations has been thorough and the means are at hand. All of us must realize, whether we get any great pleasure in the thought or not, that the high-frequency spectrum is now a highly-organized area nicely laid out in neat skinny strips, and he who gets on the wrong side of his fence is very liable to be jerked up without warning for trespass. We can still have plenty of fun—let's play the game.

K. B. W.

Official Frequency Stations

THE Official Frequency Station system furnishes a service cooperative with but differing from that of the Standard Frequency Stations, W9XL, which is also operated in accordance with plans made with the O.F.S. Committee.

The chief duties of the O.F.S. are to indicate the frequency of each transmission at its termination, to check the frequency of other transmissions when requested and to aid in the general work of keeping all amateurs within their assigned bands. The announcement of frequency at the end of each transmission will be in kilocycles and consist of four or five numerals without any punctuation whatever.

An accuracy of at least 0.5% is required of all O.F.S. and it is expected that they will check their frequency meters at least once every two months against a suitable standard or Standard Frequency transmissions from W9XL.

See page 68 of the November issue of QST.

The present list is as follows:

W6XAO-W6ZV, VE3FC, OZ2AC, W6AM, W1CK, W1AWW, W8EQ, W4XE, W5ZAV, W9EGU, W6ZH, W2MU, W4BY, W5SP, W7GQ, W2DS, W1BZQ, W6BGM-W6CVO, W9IG, W1ZL-W1AVW, W2CLA, W8GZ, W8ZG, W9BGK, EG2NM, VE9AL, W8APZ, W5OX, W1AAC, W8BZT, VE3CO, EG2OD, W6CAE, W9AXQ, W9CPM, W5EW, W1AXA, W9BGH, EG2SZ, W6BB, W8DAJ, W9AUG, VE2BE, W2BRS, VE4BT, OA-5BG, W4LK, EGG15NJ, W1CCW, W8BAU, W9UZ, W2EF, W6AKW, W6CDY-W6CRX, W6AYC, W6BRO, W6WN, W6BMW, W6CMQ, W7AAT, W9AHQ, W9EFO, W6BAJ, EG5YK, W6BZU, W1BD, W5NW, OA7CW, W6EC-W6XE, W6QX, OA5LF, W6QL, W5BG, W2DC, W9BVC and W2UV.

—H. P. W.

The Requirements of Transmitter Keying

A Review of Principles and Methods Together With Suggestions Concerning Some Modifications for 1929 Operation

By Ross A. Hull*

SHOULD you run through the vast array of text-books and manuals treating radio principles and practice and the technical periodicals devoted to the same subjects you would find a curious disregard of considerations involved in the keying of transmitters. Through hundreds of pages the tubes are arranged in a variety of circuits, adjusted to fulfill the requirements of various equations and so caused to provide the most stable frequencies at certain efficiencies. Then, when the tubes are about to become useful for radio communication the books usually lapse into a chapter on "Antenna and Radiation" or perhaps just an index. Keying probably has received wider treatment in *QST* and *The Radio Amateur's Handbook* than in all other radio publications together.

Of course, there is an explanation for this condition. Most technical manuals are written for the professional radio engineer in whose field keying is a problem only in special instances. The commercial transmitters of the present day are each provided with a frequency channel all to themselves. Usually they are located where interference with broadcast reception is not a consideration. Then, they are almost invariably crystal-controlled. Under these conditions the keying problem is just one of causing the output of the transmitter to be interrupted at periods demanded by the speed of keying.

In amateur work, however, where the transmitting antenna and the neighbors' broadcast receiving antennas make criss-cross patterns over the back fence; where the self-excited transmitter is of necessity the back-bone of most stations and where the amateur signals of all the world are boxed up in narrow frequency bands, the importance of the problem is of a very different order. And yet it is surprising how keying is neglected by amateurs except in cases where interference with broadcast listeners makes some careful consideration of it a necessity. Transmitters may be built in accordance with what is now considered good practice, they may be adjusted mechanically and electrically to give the most stable frequency and the cleanest note

but at this stage there is usually an abrupt break in the sequence of affairs. "That sure is a nifty note", is the exclamation. "Let's have that key—we'll see if we can raise someone". And the key is hitched in the center-tap, or the gridlead lead, where it usually remains to cause thumps or chirps until such time as the neighbors demand some modification. We know all that—we've done it ourselves. But times have changed. The broadcast listeners must still be considered, but now, for purely selfish reasons, the amateur is obliged to pay as much attention to the keying as any other feature of the transmitter. Investigation has shown definitely that even the very best "1929 type" carrier can be hacked into an "early 1928 type" signal if keying is performed improperly.

In previous articles we have shown that no particular difficulties are involved in building and adjusting a transmitter to give that standard of frequency stability and note character which have been styled a "1929 type" signal. So far, however, we have not treated the manner in which such a signal can be chopped into dots and dashes effectively. We are to see that the attainment of a high quality signal is one problem while the keying of it without destroying its quality is another of perhaps equal importance. We trust that we will be pardoned, therefore, if we wander off into a thicket of preamble and explanation in our attempt to tell the entire story.

One possible specification for the ideal keying system for the amateur transmitter could be outlined in this manner:

1. The arrangement should be sufficiently simple in construction and operation to be within the means and abilities of any amateur.
2. The keying should be positive at all times.
3. The output frequency should remain constant.
4. High amplitude transients or surges which give rise to "key thumps" should not result from the opening or closing of the key.
5. Rather should the wave train of each dot and dash be tapered in amplitude at the beginning and end in order to minimize shock

*Associate Technical Editor, *QST*. In Charge A.R.R.L. Technical Development Program.

excitation of neighboring receiving antennas.

6. No abnormal stress on any apparatus

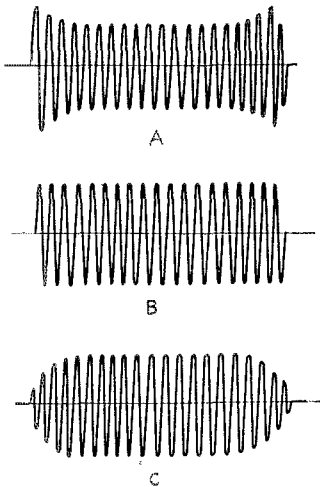

FIG. 1

SUGGESTING THE FORM OF THREE POSSIBLE WAVE TRAINS RESULTING FROM THE TRANSMISSION OF A DOT

At A the oscillation is represented as starting suddenly at high amplitude as the result of the peak voltage of the supply system reaching the tube instantaneously—a condition which would result from the use of a key in the grid, center-tap or plate leads without any "line lag" circuit. Serious thumps and a frequency "flip" would be caused. At B the oscillation is shown starting suddenly at its normal amplitude—a condition which could result from keying in the antenna circuit or from keying within the transmitter with insufficient inductance in the "line lag" circuit. The wave train C indicates a tapering of the amplitude at the beginning and end of the oscillation, the condition brought about by the use of a well adjusted lag circuit. In this case thumps would be almost completely eliminated though "chirps" would result in a self-excited transmitter if it was incorrectly adjusted.

of the transmitter should result from the keying.

7. If possible the plate load should be reduced appreciably or cut off entirely during the spaces.

There is not much doubt that these desirabilities can be attained under certain conditions. Unfortunately, however, it does not seem that these qualities can be "transplanted" into any transmitter in which the system is installed. It would seem that as much depends upon the condition in the oscillatory circuits of the transmitter as upon the characteristics of any keying method. It is on account of this that we have been unable to arrive at the point where we can specify any one system as the solution to the keying problem. And it is for this reason that we must attempt a comprehensive treatment of the considerations in order

to make it more readily possible for the amateur to select the system which most suits his conditions and then to solve the minor problems which will be met in the adjustment of it.

The requirements with which we are to be particularly concerned in the occupation of our new bands are those numbered 1, 3 and 4 involving simplicity, constancy of frequency and thump elimination. It is almost too obvious to require mention that any system fails to provide a solution for the keying problem unless it is inexpensive and simple. Without these characteristics the system could never be generally and successfully adopted. Constancy of frequency is now a requirement of prime importance on account of the narrowness of the bands and the growing use of highly selective receivers. Signals of constant frequency can be held on the peak of a highly selective amplifier and read through interference which would swallow a signal that chirped or wandered over a kilocycle or so. The consideration of key thumps is listed in the "big three" since the problem of interference with broadcast reception must always be a concern

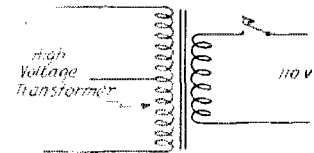

FIG. 2

of the amateur. In addition, though, we must remember that key thumps can constitute a source of interference even within our own bands.

And so, having decided what we would expect of the ideal system we can examine the difficulties in our way and the possible methods of overcoming them.

The question of simplicity—the first of the problems as we have listed them—is really also the first in importance. Thump filters and other appendages have been devised from time to time but they have been used only by amateurs haunted by neighboring listeners or by particularly sincere or ambitious men. The arrangement in most general use has been a simple key which even if it was not perfect, at least chopped the signal into readable dots and dashes in the simplest possible fashion. Except in special cases it would now seem that the true "1929" transmitter cannot possibly be keyed with a straight key, and in urging every amateur to install some keying refinements we hope to be able to present at least some reasonably simple ones. At the same time we are obliged to admit that the

simplicity question is still inadequately answered. In the laboratory work we have found it a straight forward matter to arrange a near-perfect system providing enough chokes and resistors of the right values were available. We have been able to reduce the systems to a thoroughly practical form, however, only by sacrificing their effectiveness.

The operation of the practical keying systems is hampered in most cases first by the fact that few stations have a power supply with good regulation. In almost all instances the plate voltage and sometimes the filament voltage makes a dip when the tube takes its load. The frequency of the tube output is dependent to some extent upon the voltages and we are, therefore, immediately faced with difficulties in attaining the next important desirability—constancy of frequency. In many cases it is impractical to install a special heavy duty power supply line which would avoid regulation troubles and the keying system thus becomes entangled with considerations of the high voltage transformer, rectifier and filter system. Also it immediately is tied in with the problems of transmitter tuning, which, as we know, are concerned greatly with the reduction of frequency changes due to variation of tube supply voltages.

Yet another difficulty in the attempt to obtain frequency constancy is due to the fact that the frequency output of any but crystal controlled transmitters will vary as the heating of the plate changes. If, in keying, the load is to be removed from the

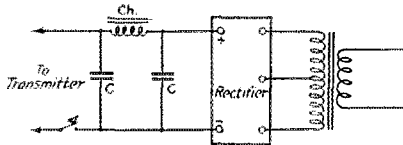

FIG 3

plate during the spaces, frequency changes will occur. If, on the other hand the keying system is so arranged that the load will be on the tube continuously, then the tube will heat more seriously than before and the net result will be to replace the irregular frequency changes by a relatively constant and probably more drastic one. On account of these considerations also, it is seen that the problems of keying are closely associated with those of transmitter tuning.

The question of key thumps rotates around the fact that consequential thumps result if the voltage in the antenna climbs to its full value at too rapid a rate. The key thump elimination problem for the amateur therefore consists in making some provision which will permit the antenna voltage to

build up gradually. The making of this provision is made difficult by the fact that if the tube is caused instantaneously to oscillate at full amplitude, the antenna voltage, in the usual antenna, will build up too quickly. If the tube is made to climb into full oscillation slowly by introducing a lag in the supply circuits, further complications as introduced by the fact that the frequency will be changing as the supply voltages are climbing to their normal value. A rapid frequency "flip" will then be found at the beginning and end of each character. Careful tuning also is to help greatly in this

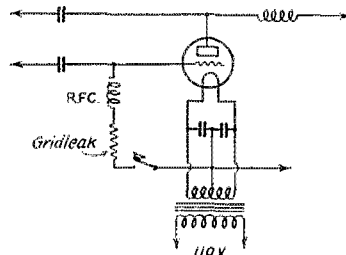

FIG 4

case. In the same connection we have another consideration which must be understood. When we speak of a 2,000-volt transformer we are referring to its effective or root-mean-square voltage. The voltage output of the transformer is, of course, varying constantly from zero to a peak value and back again and this peak value is 1.41 times that of the r.m.s. output. Now if the key is arranged in such a way as to disconnect the tube from the filter circuit during the spaces the condensers in the filter will become charged to the peak voltage of the unloaded transformer. Then when the key is closed, unless special precautions are taken, the tube will receive a special kick at the start of each character from this peak voltage. The result, far from being a gradual building up of oscillations, will be the sudden starting of oscillations of unusually high amplitude tapering, after a fraction of a second, to the normal value. Under these conditions a thump and a frequency "flip" of serious proportions would most certainly result.

And there is even another factor with which we are to be concerned in thump elimination. It is that when the contacts of the key open a spark occurs, this spark resulting in a thump. If the key is located where it breaks appreciable power it will be found that provision must be made for the reduction or prevention of this spark.

And here we find ourselves with a great many words behind us and nothing said as yet of practical keying. This is unavoid-

able, though, since we believe that we must insist that satisfactory keying can only rarely be accomplished by following a wiring diagram. It has been our conclusion that the amateur must know what he is trying to do with the keying apparatus in order that he may be able to arrange it and adjust it with the least difficulty.

The practical keying methods, to get down to brass tacks, can be resolved into four general divisions. They are:

- (a) Interruption of the primary circuit of the plate supply transformer.
- (b) Breaking of the high voltage supply to the plate.
- (c) Variation of the mean grid potential—"blocking" of the grid by negative bias.
- (d) Interruption of the oscillatory energy in the output circuits.

Other practical schemes involve a combination of two or even three of these.

Scheme (a) is limited to transmitters in which the time lag in the high voltage circuit is something less than about 1/50th of second—assuming that keying is to be at the usual hand speeds. If the lag was greater

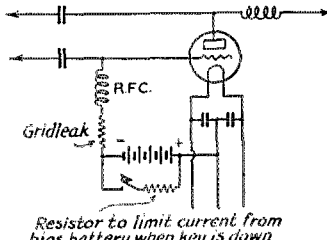

FIG. 5

than this a perceptible "tail" on the signal would make it difficult to read. Clearly the scheme, shown in Figure 2, is of little use in any transmitter which is fitted with an effective filter. At the same time it is full of possibilities in connection with the amplifiers of a crystal controlled set in which a simple filter usually is sufficient to obtain a pure note. Experiment has shown also that it could be effective when used with a High-C transmitter carefully tuned—for a transmitter of this type can also be made to give a note of excellent quality with but a small filter. In the case of "self-rectified" transmitters this scheme (a) is also of service, though the cushioning effect of a small filter is absent. Unless the transmitter is of low power there will be heavy sparking at the key contacts in any case. For this reason a relay with particularly heavy contacts is desirable.

Scheme (b), the interruption of the high voltage circuit, is the one obvious method of

keying a transmitter equipped with an effective filter. It is, however, the scheme most likely to produce trouble unless precautions are taken. Let us examine the case of a straight key placed in the negative high voltage lead.

Assuming that the transmitter has been adjusted satisfactorily and that the key in Figure 3 is open, the condensers C will become charged from the transformer-rectifier system to almost the peak voltage of the transformer. At the moment when the key is closed the transmitting tube will receive this peak voltage and will break into oscillations of abnormally high amplitude. This first burst of activity will last only for an extremely small fraction of a second until the load taken by the tube reduces the charge on C to the normal voltage under load. At the moment when the load came on the transformer, the voltage output dropped as the result of poor regulation and after overcoming the lag introduced by the choke Ch, this drop appears at the tube, reducing the amplitude of its oscillation to the normal steady value. But this is only half the story for we know that changes in plate voltage cause changes in the oscillation frequency. When the supply voltage made its dive at the closing of the key not only did the amplitude of oscillation change but also the frequency output flipped simultaneously; the net result of the whole procedure being the production of a heavy thump due to the sudden starting of particularly heavy amplitude oscillations and a drastic frequency flip due to the change in supply voltage. At the opening of the key a flash would occur at the contacts resulting in another thump and frequency splash, probably of lesser proportions.

In order to overcome these troubles and reduce this system to a practical form it is now clear that we require:

1. A means of preventing the filter capacity from charging to the peak voltage of the transformer.
2. Some refinement to improve the regulation of the plate supply.
3. A reduction of the frequency change with plate voltage change in the transmitter.
4. Apparatus effective in reducing the flash as the key is opened.
5. The introduction of a time lag so that oscillations, even of normal amplitude, will not build up suddenly.

Since these requirements are common to most keying systems, we will postpone consideration of them momentarily.

Scheme (c), the blocking of the grid, is another sound method of stopping and starting oscillations for the work can be done at this point with less electrical effort than elsewhere in the transmitter. The simple connection of the key as in Figure 4, how-

ever, does not by any means constitute a "1929" type keying system. As in the previous case the filter capacity becomes charged to the peak voltage of the supply unit when the key is up. When it is closed the tube receives the same voltage kick as in the plate lead keying system and the same sort of thump and frequency flip result. The spark at the contacts is now very much less on account of the lower current in this circuit but other troubles are introduced by the fact that in some tubes the grid does not accumulate a sufficient negative charge when free to completely "block" it. The grid can be provided with an external source of negative charge to overcome this, as shown in Figure 5 but the major faults of the system still exist. With the possible exception of Number 4 the requirements for this system are the same as those of scheme (b).

The method listed as (d), the interruption of the energy in the output circuits, has the immediate advantage that the tube may oscillate continuously, so making it impossible for the filter to become charged to the peak voltage and so avoiding some of the difficulties due to poor regulation in the power supply. The arrangements shown in Figure 6 still have the disadvantage that the antenna is bumped into sudden oscillation and possess the ability to provide a heavy radio frequency spark at the contacts as the circuit is broken. The necessary refinements for this method could be listed as:

1. A means of introducing a lag in the building up of oscillation in the antenna.
2. Provision for the avoidance of flashing at the contacts.

OTHER CIRCUITS

Some possible combinations of two of these four methods, (a), (b), (c) and (d), are given in Figure 7. At A the double contact key or relay is arranged so as to break the primary of the high voltage transformer simultaneously with the negative high voltage circuit, the idea being to avoid permitting the filter capacity to become charged when the key is open. The arrangement shown at B is a combination of schemes (b) and (c). In this case the breaking of a single lead interrupts both plate and grid circuits. A great many other combinations are possible.

REDUCING THE SYSTEMS TO PRACTICAL FORM

In considering the attainment of the desirable refinements let us first talk of requirement Number 1—a means of preventing the filter capacity from charging to the peak voltage of the transformer. Of the basic keying systems only (a) the interruption of the plate transformer primary can be freed from this consideration.

Perhaps the most direct solution to the

problem is that shown in Figure 8. In this case a double contact relay serves to disconnect the filter when the key is up. During the spaces the filter will—if the condensers are in good condition—retain its charge and only the normal voltage will be obtained when the key is closed. Troubles would be introduced if the two contacts did not open and close at exactly the same moment and for this reason careful adjustment of the relay would be essential.

The use of a double contact relay which breaks the primary of the high voltage transformer in addition to the negative high voltage lead is another method of preventing the filter capacity from becoming charg-

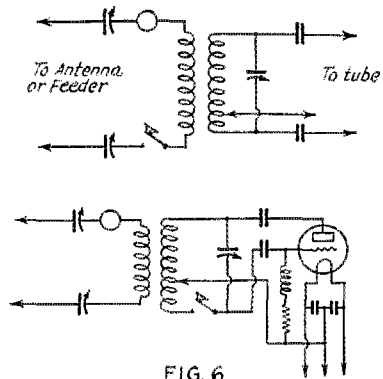

FIG. 6

ed to the peak voltage. As shown in Figure 7A a resistor can be placed across the contact in the primary circuit so that when the load is taken off the output of the filter the input voltage to it is reduced by an amount necessary to keep the voltage across the filter capacity constant at all times. A high voltage voltmeter is desirable in order to permit correct adjustment of the resistor R. The two relay contacts, in this arrangement, must always be adjusted so that the contact in the high voltage lead opens after that in the primary and closes before it, that is, unless they operate exactly simultaneously.

A simpler scheme is that shown in Figure 9. In this case a resistor is connected across the output of the filter so that there is a continuous current flow from the supply system. In this way the condenser is never permitted to maintain a charge equal to the peak voltage. Unfortunately, however, its charge will be somewhat higher than the normal operating voltage on load, its exact value being dependent upon the capacity of the condensers and the resistance of R. As R is reduced the voltage built up during the keying spaces is less but it does not come down to the normal operating voltage until the load drawn by R is equal to that taken

by the tube in operation. Then the voltage would stay constant only if R was removed at the instant that the tube started operation. Which simultaneous removal is rather impractical.

Considerations of simplicity, cost and reliability of operation it would seem, boil the situation of the peak voltage down to the use of a resistor across the filter output—the resistance and current carrying capacity of the resistor to be determined by the voltage of the supply and the permissible current drain from the plate supply

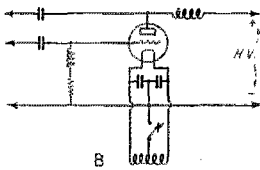
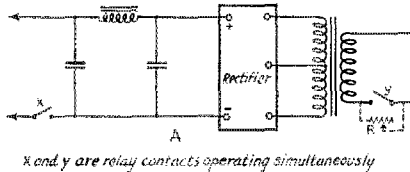

FIG 7

additional to that taken by the tube. A practical value of drain current through the resistor has been found to be about 25% of the tube plate current. For a transmitter employing a single UX-210 this would therefore be approximately 15 m.a. The value of the necessary resistance is ob-

tained by Ohm's Law $R = \frac{E}{T}$. For a 500-volt

supply it would therefore be 500 divided by .015, the result being about 33,000 ohms. In most cases, particularly if the new mercury vapor rectifiers are used, a much greater drain than this can be afforded and the necessary resistance so reduced. A resistance of 20,000 ohms, which would give a drain of 25 m.a., would be permissible in many cases. The points to remember are that as the resistance is lowered its effectiveness in reducing the condenser charge is increased; but that beyond a certain point, depending on the constants of the circuit, this increased effectiveness is at the expense of smoothing action in the filter; that the low drain currents require a somewhat expensive amount of resistance but that the high drain currents require resistance of higher current rating, making the expense probably of the same order. For the low current drains necessary with tubes

of the UX-210 or UX-852 type, it is possible that a satisfactory resistor could be built up from "B eliminator resistors" obtainable from most "10 cent" stores. For the higher drain currents, grid leak resistors of suitable current rating would be effective.

THE REGULATION PROBLEM

And now, when we examine the second necessary refinement of our list we are faced with one bright fact. It is that the resistor which we have just mentioned is in itself a partial solution to this second problem. It certainly will serve to make a plate supply with poor regulation fair and a supply with good regulation better. At the same time it is not necessarily a complete answer. In order to attain good regulation in the supply circuits it is first necessary that the regulation of the supply line is good. Assuming that the filament is lighted from a separate transformer a simple check on this is to throw the tube load on and off by keying the transmitter; at the same time watching the filament voltmeter. If the filament voltage flickers more than about .1 volt, it is evident that something should be done about the supply line. The difficulty often can be overcome by running the plate transformer from one power outlet and the filament transformer from another. In the case of high powered transmitters, however, this may not be effective and the installation of a heavier supply line may be desirable. Providing the filament voltage stays constant during keying, attention should be given to the high voltage supply system. The most direct check of the high voltage regulation is to connect a voltmeter across the output and note the fluctuations in voltage caused by keying. With the Kenotron rectifiers usually employed in the amateur station, it will be found that an appreciable drop in voltage as the load is thrown on cannot be avoided. With the new mercury vapor tubes or a mercury arc rectifier, however, it should be possible to obtain a supply voltage which does not change more than 15% as the load is thrown on and off. In many stations a high voltage meter will not be available and for the check a d.c. milliammeter connected in series with the drain resistor at M in Figure 9 can be used. The plate meter will serve effectively for this purpose.

Aside from considerations of the rectifier tubes, poor regulation in the high voltage supply system can be caused by the use of a transformer or choke of too low a rating. We insist upon the desirability of using a high voltage transformer with a power rating of at least three or four times the power input with which the tube is operated. Similarly, in the case of the filter choke and any other chokes in the high voltage sup-

ply leads, we would suggest the use of chokes with a rated current carrying capacity of at least twice that of the normal plate current. The use of such over-sized transformer and chokes may entail more expenditure but the added cost will be completely justified. In this discussion we have assumed that the high voltage and filament transformers are separate instruments. If this is not so it is almost certain that difficulties will be faced in maintaining a constant filament voltage unless the rating of the combined transformer is a great many times that of the total load to be placed on it. Filament flicker, of course, affects the output frequency of any but crystal controlled transmitters. The lag between filament voltage and filament temperature makes the change in frequency from voltage fluctuations a relatively slow process and, as a result, serious frequency "chirps" can be caused as the transmitter is keyed. It is possible to arrange contacts on the key or relay to short a resistor in the filament circuit when the key is down, so compensating for the voltage drop on load, but the scheme is quite complicated. It is our firm belief that a separate filament transformer should be used in all cases.

PLATE VOLTAGE VS. FREQUENCY CHANGE

In our list of necessary refinements we have as the third item "A reduction of the frequency change with plate voltage change in the transmitter." Consideration of the extreme desirability of such a reduction and possible means of accomplishing it have been given lengthy treatment elsewhere in this and past issues of QST.¹ We will not attempt to cover the ways and means in detail in this discussion but we feel that we must stress the particular importance of the problem in the field of keying.

In the average poorly designed and poorly adjusted self excited transmitter it is possible for a 75% drop in plate voltage to cause a frequency change of the order of 15 kc. When the transmitter is keyed with a straight key in the center tap lead, it is therefore possible for a frequency flip to occur in which the output frequency swings over about 10 kc. Key clicks on the band in which the transmitter was working undoubtedly would result. The much sadder part of the story, however, is that if the keying system was arranged and adjusted with the greatest care so as to give a tapered wave train as in Figure 1C the frequency flip would be replaced by a slower frequency chirp extending over the whole 15 kc. and capable of greater interference than before. An approximate statement in summing up this condition is that in any poorly adjusted self-excited transmitter key-

ing must result in either clicks or chirps. It is only when the frequency change due to plate voltage change is negligible that the tapered wave train so essential to the elimination of clicks can be used without creating a consequential chirp. And it is only when the self-excited transmitter is correctly arranged and adjusted that frequency change is reduced to a negligible quantity. Perhaps the greatest single factor in improving the plate voltage-frequency char-

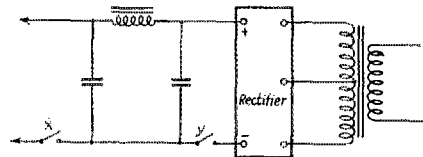

x and y are relay contacts operating simultaneously

FIG. 8

acteristic is the use of a High-C tank circuit. Other important requirements are; careful adjustment of grid leak resistance, grid excitation, antenna coupling and antenna tuning. Naturally, the monitor is of the greatest value in permitting the effect of these and all adjustments of the keying system to be observed.

REDUCING CONTACT SPARKING

As the fourth refinement we have listed the reduction of flashing at the key or relay contacts. If we could take a "slow movie" of the opening of the contacts we would find that at the moment when the contacts first separate the voltage behind the key builds up and arcs across the gap between the contacts. As the contacts continue to separate the length of the air gap is increased to the point where the voltage is insufficient to maintain the arc. If a path has been provided across the contacts which would momentarily provide a place for the current to go when the contacts first opened the arc would never have been started. Such a path can be provided without difficulty in the manner shown in Figure 10. The action of the condenser resistance combination could be explained very approximately by saying that when the contacts first part company the oncoming voltage finds that it is easier to flow through the resistance R into the condenser C than to break down the air gap between the contacts. By the time the voltage has fully charged the condenser C it finds that the contacts have opened too wide to permit it to jump the gap. The resistance has the effect of slowing down the charging rate of the condenser and its work is therefore of great importance. If it were not present the condenser would be charged almost in-

1. QST, August 1928 page 9. QST, September 1928 pages 9 and 25.

stantaneously and it is possible that there would still be time for the voltage to jump across the contacts before they had opened beyond the critical point. The resistance also serves to slow up the discharge of the condenser when the contacts are about to close, so avoiding a flash at the time when its charge is dissipated. Unfortunately no values for the capacity and resistance can be given which will serve under all conditions. A 1- μ fd. condenser and a 400-ohm potentiometer type variable resistor usually will permit of satisfactory adjustment, however.

INTRODUCING A TIME LAG

The use of an inductance in the circuit being keyed in order to introduce a time lag and so taper off the wave trains has

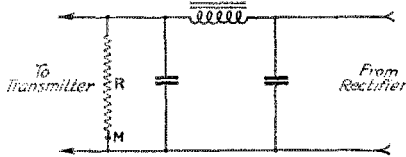

FIG. 9

been common practice for many years. An inductance has the property of opposing any change in the magnitude of a current and its use is therefore the obvious method of introducing the necessary lag. In the past a great many thump filters have been described, each one having as its foundation an inductance in series with the grid or plate wiring in which a direct current is flowing. Unfortunately they have not been generally successful, chiefly on account of the difficulty of adjusting the inductance to the value necessary. On account of the poor frequency-plate voltage characteristic of many transmitters any choke which had sufficient inductance to taper the wave trains caused a frequency chirp or "tail." Chokes of lesser inductance avoided the chirp but left a click or thump. Further, it was found that constants given in a QST article on some successful arrangement did not work out satisfactorily in another transmitter. It was not appreciated by the amateurs using the systems that the desirable constants were dependent upon the constants of the filter used, the adjustment of the transmitter and the particular value of plate current at the moment. A wide variety of chokes of different values rarely exists in the amateur station and, as is testified by many hundreds of Information Service queries, thump filters were widely considered the bunque. The very same circuits are to be recommended in this discussion as have been suggested

all along but there are two factors which should contribute towards making them more practical than they have ever been. First they are specified to be used with a transmitter in which the frequency change for a 100% change in plate voltage is not more than two or three hundred cycles—a condition which can be attained readily by using a High-C tank and by careful tuning. Then, the chokes are provided with a practical means of varying their inductance continuously. The time lag circuit consists therefore of a choke, sometimes used in conjunction with a condenser, the choke being shunted with a variable resistor. Some effective systems are shown in Figure 11. At A the key and time lag circuit are arranged in the plate lead and in consequence the choke should be capable of carrying the plate current without excessive voltage drop. Whenever possible a special transmitter type choke of between 5 and 10 henries should be used but in the case of a transmitter employing a UX-210 tube a "B eliminator" choke, or two of them in parallel, could be made to serve. In the arrangement in which the choke is in the grid circuit the primary of an audio frequency transformer can be put into service for the lower powered transmitters while a "B eliminator" choke can be used for medium or high powered sets. A suitable resistor for use across the choke is specified under Figure 11.

ADJUSTING THE SYSTEMS

The adjustment of any of these systems can be carried out most effectively with the aid of a monitor. The first move, of course, is to adjust the transmitter with the key down until the cleanest possible note is obtained. With any given filter this condition will be obtained when the frequency change due to plate voltage change is at a minimum. In getting the cleanest note one therefore puts the transmitter in the best

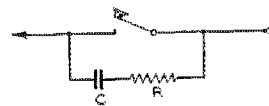

FIG. 10

condition for successful keying. A valuable check on the adjustment of the transmitter can be made by connecting one or two lamps in series with the primary of the high voltage transformer so that the output voltage is reduced by, say 50%. A switch is then arranged so that these lamps can be shorted out. Opening and closing the switch then provides a sudden change in plate voltage and, if the transmitter is

poorly adjusted, the process will result in an appreciable change in the output frequency. By listening in the monitor the extent of the frequency change can be observed and adjustment can be continued until it is at a minimum. With the average

conditions even a very gradual taper on the wave trains, which ordinarily would give a serious chirp, would be tolerable.

In adjustment of the shunt resistor R2 it is as well to listen with the monitor tuned to zero-beat with the transmitter for pos-

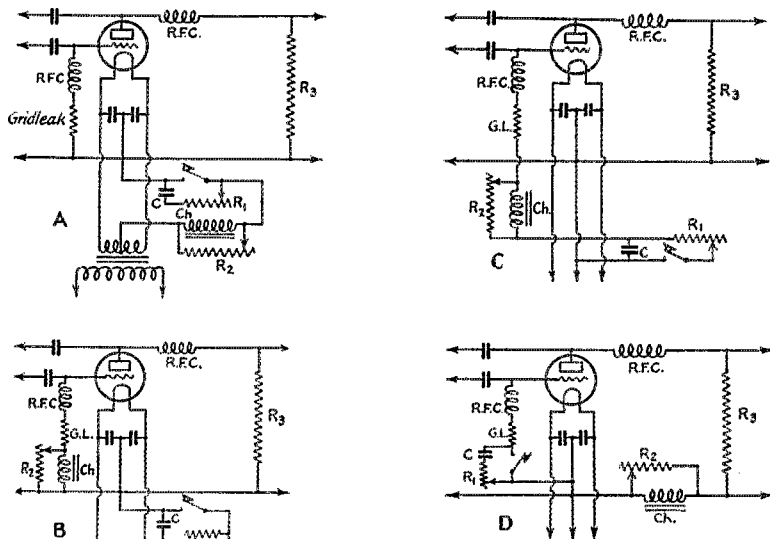

FIG. 11

SOME PRACTICAL KEYING ARRANGEMENTS INVOLVING THE USE OF AN INDUCTANCE TO PROVIDE A TIME LAG

At A the key and lag circuit Ch., R2 are connected in the center tap lead, so operating in both the plate and grid d.c. circuits. In this case the inductance Ch. must be capable of carrying the grid and plate currents without undue voltage drop. At B the key is in the center-tap lead while the lag circuit is in the d.c. grid lead. The inductance in this instance can be of much lower current rating than that used in A. The arrangement is therefore useful in cases where the available choke is not wound with sufficiently heavy wire to serve in the plate wiring. In the circuit C both key and choke are in the grid circuit a scheme which is particularly suited for high-current tubes with which key sparking, when the plate circuit is broken, is often difficult to eliminate. The arrangement D shows the key in the grid circuit and the lag circuit in the plate lead. This connection is well adapted for use with high-current tubes also since key sparking is readily eliminated and the lag circuit is in a position where it can play second part in reducing the possibility of sudden high voltage surges reaching the tube during keying. It is a useful arrangement when the available choke happens to be heavy enough for service in the plate circuit. The resistor R3 (described in the text) performs a function essential to the successful operation of any of the circuits in

reducing the peak voltage built up in the filter during the keying spaces.
 R1—Variable resistor of wire wound or carbon-pile type, 400 or 500 ohms.
 R2—When Ch. is of the order of 30-50 henries, 10,000 ohms. When Ch. is between 5 and 10 henries 5,000 ohms. For operation in the grid circuit or the plate circuit of low-powered transmitters resistors similar to the Bradleyohm are serviceable. For most plate circuits, however, wire wound resistors or carbon-pile resistors similar to the Bradleyleak are necessary.
 R3—Wire wound resistor between 20,000 and 80,000 depending on tube used. See text.
 C—.5 or 1 µfd. fixed condenser, voltage rating of at least half plate voltage when used in grid or center-tap. Voltage rating equal to filter condensers when used in plate lead.
 Ch.—Audio frequency transformer secondary for use in grid circuit of low powered transmitter. Good "B Eliminator" choke for grid circuit of medium or high powered transmitter. When used in center-tap or plate lead a choke rated well above plate current of tube is necessary. Inductances between 5 and 50 henries are suitable providing R2 is of the correct value. In some cases a smaller choke may be found effective without R2.

self-excited transmitter fitted with a High-C tank the frequency change resulting from a sudden 50% plate voltage change can readily be reduced to the order of 1/350 per cent (200 cycles at 7,000 kc.) Under such

sible thumps and with the beat note at about 500 cycles for any possible chirp. No difficulty will be had in finding the adjustment half way between the thumps and chirps.

KEYING THE RADIO FREQUENCY CIRCUITS

Experiment has indicated that it is not readily possible to key in series with the tank circuits or the feeder of antenna without producing thumps. At the same time such keying is particularly free from chirps and has the advantage that the plate supply system can be loaded continuously. In cases where interference with broadcasting is not

is radiated. In installing such a system it is important that the contacts are at a point of low voltage in the system. Perhaps the best plan is to place the relay within six inches or so of the antenna coil, adjusting the series condensers until the voltage node is at the center of the inductance. A neon bulb is almost indispensable in determining the location of the node.

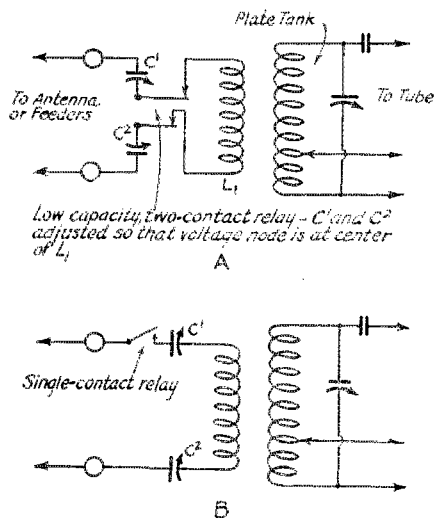

FIG. 12

KEYING AT A VOLTAGE NODE IN THE ANTENNA OR FEEDERS—A SCHEME RECOMMENDED ONLY FOR THE 3,500- OR 1,715-KC. BAND

When the series condensers are adjusted so that the two r.f. meters show the same reading there will be a voltage node near the center of the antenna coil and sparking at the relay contacts in circuit A will be at a minimum. What is more important, the capacity between the open contacts, under these conditions, will be least effective in permitting the radiation of a "back-wave." In scheme B a single contact relay is used and by the manipulation of condensers C1 and C2 it is possible to bring the voltage node right at the relay when sparking and the "back-wave" may be less noticeable than with scheme A. The location of the node can be found conveniently by listening to the transmitter in the monitor then touching the antenna or feeder wiring at different places with a screw-driver. When the location of the voltage node is touched the least frequency change will be caused. Neither system is particularly free from thumps though the keying can be made unusually "clean".

a consideration they might well be put into service. Keying in the feeders or antenna as shown in Figure 12 provides the possibility of a particularly steady frequency when adjusted correctly but its use has been found satisfactory only on the 3,500 or 1,715 kc. bands. On the higher frequencies, even if a relay with low capacity contacts is used, it has been found that a back wave

SPOILING A GOOD KEYING SYSTEM

One of the most important of many unsolved problems in the self-excited transmitter is the elimination of the frequency changes resulting from changes in plate temperature. In any self-excited transmitter the frequency can be held extremely constant, once the tube has heated fully, just so long as it is left in full oscillation. Unfortunately a keying system which changes the load on the tube also changes the plate temperature and some frequency shift results. If the system is one which permits the tube to oscillate continuously, the plate heats more rapidly and attains a higher temperature, making the result about as sad. The use of a High-C tank is of considerable value in reducing the trouble on account of the fact that the tube capacity is then a lesser percentage of the capacity across the tank coil. Even so, the difficulty still exists. At the moment we find that our only recommendations are that the tube is always operated so that the plate is never run at the temperature which shows color when the filament is suddenly switched off. In High-C transmitters, providing the input does not exceed the tube rating, this condition can be obtained readily.

Another way in which keying can be made to wreck a good signal is by mounting the key or relay where it will cause the transmitter to vibrate. It is very desirable that the key be mounted on a table separated from that on which the transmitter is located. When a relay is used it also should be on a separate mounting, preferably one attached firmly to the wall. An alternative scheme involves mounting the relay on rubber sponges.

The relay itself is an important item. In any system where keying is accomplished in the radio frequency circuits a relay is essential to avoid hand-capacity effects. When keying is performed in the plate circuit or the center-tap of a transmitter operating from more than 500 volts the use of a relay is also of the greatest importance. In fact, it is considered good practice to use a relay in all keying systems.

SOME SPECIAL SYSTEMS

The keying of a well adjusted master-oscillator-amplifier transmitter and particularly that of a crystal controlled transmit-

ter is in general simpler than the keying of self-excited transmitters since the frequency-plate voltage change is not a consideration. Thump elimination, in these cases, is the one important object and it is

of receiving a shock. It is probably preferable to arrange the key and lag circuit in the amplifier grid lead as in Figure 13.

Similar arrangements can be used for the crystal controlled transmitter.

Other more complex arrangements could be drawn up in dozens—the circuits given represent but a few of the hundreds of possible variations. A great many others have appeared in QST from time to time and undoubtedly will continue to appear. The important points are just that all of them are aimed to accomplish the same result and that it is an understanding of the objectives and possible means of attaining them which will be of the greatest service in the adjustment of any of them or the evolution of others.

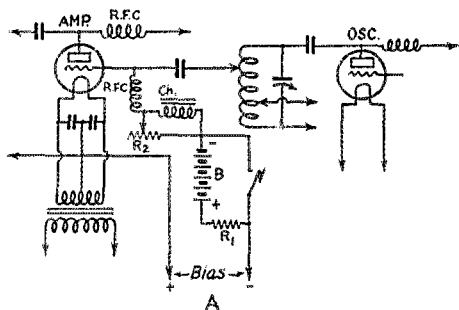

A

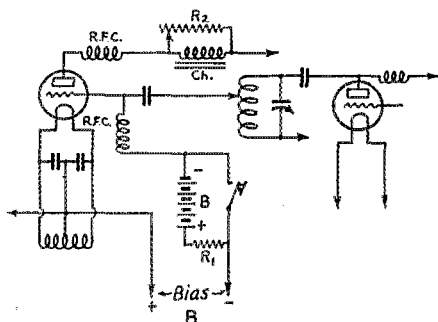

FIG. 13

KEYING SYSTEMS PARTICULARLY SUITED FOR USE WITH M.O.P.A. OR CRYSTAL CONTROLLED TRANSMITTERS

In the circuit A the time lag unit is in the bias lead to the amplifier grid. In most cases the mere opening of the grid circuit will not prevent the flow of amplifier current and for this reason the battery B is included. Its purpose is to hammer the amplifier grid negative when the key is up. The resistor R1 is used to limit the current flowing from B through the key when it is down. A 5,000 ohm gridleak will serve when B does not exceed 45 volts. A proportionately higher resistance is required when B is of a higher voltage. B is adjusted with the key up until the amplifier plate current is zero.

The connection of the lag circuit in the high voltage supply to the amplifier as in circuit B is desirable when medium or high power is used in order to provide a "cushion" against plate voltage surges during keying. Ch. and R2 are as specified under Figure 11.

simplified greatly by the fact that the wave trains can be tapered without serious frequency chirp. The amplifier of a master-oscillator transmitter can be keyed in the plate circuit though this requires the connection of the key and time lag circuit in the positive high voltage lead if the oscillator and amplifier are operated from a common plate supply. A relay would be essential in such a case to avoid the danger

Standard Frequency Transmissions From W9XL

Schedules for February

Schedule "A"		Schedule "B"	
Central Standard Time (P.M.)	Frequency in kc.	Central Standard Time (P.M.)	Frequency in kc.
8:00	7,300	3:00	30,000
8:12	7,225	3:12	29,000
8:24	7,150	3:24	28,000
8:36	7,075	3:36	14,400
8:48	7,000	3:48	14,300
9:00	4,000	4:00	14,200
9:12	3,750	4:12	14,100
9:24	3,500	4:24	14,000

Division of Time

4 minutes—CQ CQ CQ de W9XL W9XL W9XL.

3 minutes—series of letter "d" with the dash about five seconds long and broken every half minute for station call letters.

1 minutes—frequency—kc.

4 minutes—time allowed to change to next frequency.

DATES OF TRANSMISSION

February	Schedule
3d	"B"
8th	"A"
22d	"A"

All O.F.S. should use these transmissions to keep their frequency meters calibrations within the required limits of accuracy. It will be appreciated if you will send us a report on your reception of these signals.

See page 8 of the November issue of QST.

—H. P. W.

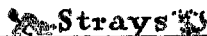

There is another reason why you should "pin" an ARRL emblem to your car. W5AMK had one on his car and five hours after it had been stolen, it was recovered by the police. He believes the yellow and black diamond had a great deal to do with it.

A New Type of Rectifier Tube for Amateur Use

O. W. Pike* and H. T. Maser*

The matter of obtaining suitable rectifiers for plate supply systems for amateur transmitters has been one upon which much work has been expended. Practically all rectifiers have some bad disadvantages: the chemical rectifier is cumbersome and sloppy, the Kenotron has a high internal drop and the mercury arc requires a large amount of accessory equipment. This article describes a new mercury vapor, thermionic tube that combines the simplicity of operation found in the Kenotron with the low internal drop characteristic of the mercury vapor tube. It bids fair to become the most important development in rectifiers that the amateur has yet seen and at this time when we are looking about for suitable power supply systems for our "1929" transmitters, it is of extreme importance to us.—Editor.

THERE has recently been developed for amateur use a new rectifier tube known as the UX-866, involving a new principle of operation. This tube is known as a hot cathode mercury vapor rectifier, and the purpose of this article is to tell something of its characteristics and the best conditions for its use.

The new tube employs a hot cathode of the "Wohnelt" type and contains mercury vapor. It differs from the usual mercury arc tube in two ways. First, it operates at relatively low temperatures so that the vapor pressure of the mercury is low. This results in a high breakdown voltage between the electrodes in an inverse direction. Second, the rectified current is made up of electrons emitted from the filament rather than from a pool of mercury. In this respect the tube is similar to the ordinary high vacuum two-electrode rectifier tube but it differs from the high vacuum tube in that the ionized mercury vapor neutralizes the electron space charge around the filament. This means that where in the vacuum tube a hundred volts or more might be required to give a certain plate current the mercury tube will give the same current with only about 15 volts between plate and filament. Of course, just as in the vacuum tube the current can never be greater than the electron emission of the filament, but up to this point the voltage necessary to pass the current is practically independent of the current and is never more than about 15 volts.

It may seem strange that the current can increase without an increase in voltage until it is remembered that as the current increases more positive ions are formed which further neutralize the electron charge around the filament and permit additional electron current to flow.

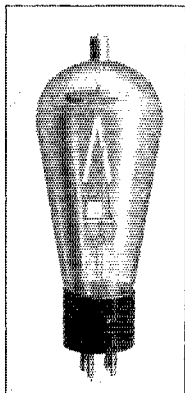

RADIOTRON
UX-866

This tube borrows a little from most all the types with which we are familiar. The filament is of the flat ribbon coated type drawing 5 amperes at 2.5 volts. The plate is about as large as a quarter dollar and its edge is turned down towards the filament. The plate lead terminates in a cap such as is found on the 222 and the glass envelope is similar in size to the 210.

The cathode is a coated ribbon filament which quickly assumes its operating temperature when the filament voltage is applied. This type of filament is especially well suited for operation in mercury vapor and is not harmed by high inverse voltages; that is, voltages in a reverse direction during the half cycle when no current is flowing. As the voltage drop within the tube is always low there is no harmful ionic bombardment of the filament, since the ions which do strike the filament are moving slowly.

The low voltage drop in this tube results in increased d.c. rectified voltage for a given a.c. supply and also improves the voltage regulation characteristics of the rectifier. The only reduction in rectified voltage when the load is increased is due to the drop in the transformer and filter windings. The low tube drop also allows the use of circuits employing rectifier tubes in series which is not usually a desirable connection when using high vacuum tubes.

The low drop is largely independent of tube geometry so that a simple inexpensive electrode structure is possible. This results

in a somewhat smaller tube than a high vacuum tube having equivalent output.

As with high vacuum thermionic tubes, this type of mercury rectifier does not re-

*Research Laboratory, General Electric Company, Schenectady, N. Y.

quire the usual starting mechanism, as electron emission is available as soon as the filament is lighted.

The tube is designed so that under normal voltage and current conditions, its operation is independent of temperature up to an ambient temperature of 50° C. (122° F.) Higher temperatures are not usually encountered but if under special conditions the ambient is greater than 50°, an air blast

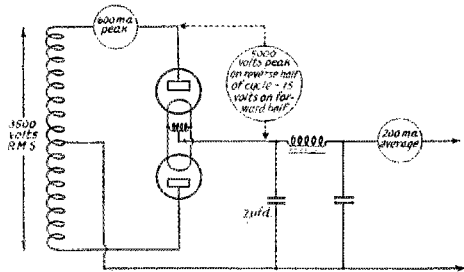

FIGURE 1. TWO TUBES ARE USED IN A FULL-WAVE RECTIFYING CIRCUIT

With condenser input to the filter, the peak current through each tube is approximately three times the average output current from the two tubes. This filter arrangement should be used where the output voltage is relatively high and the output current is low.

should be used in such a manner as to cool the lower portion of the tube.

The method of rating this tube differs from that used in the past with vacuum tubes and may require some explanation. Heretofore, rectifier tubes have usually been rated on the basis of a.c. supply voltage and the d.c. load current. Occasionally the d.c. voltage was also given. This method was very convenient where there was little variation from the usual single-phase full-wave circuit. However, with the low voltage drop of the mercury vapor tube it is possible to make use of a variety of circuits, some of which involve the use of tubes in series. The former method of rating then becomes incomplete and often misleading. For this reason the rating of this new tube is stated in terms of the fundamental limits of the tube. There are two such limits. The first is the maximum peak inverse voltage which is the safe flash back limit which the tube will stand while operating within the rated temperature range. The other limit is the peak current through the tube, which is dependent on the emission available. In the UX-866 these are 5,000 volts and 0.6 amperes respectively.

The peak inverse voltage in single phase circuits may be taken as 1.4 times the total transformer voltage (r.m.s. value). The peak plate current is not as easy to determine as it depends upon the filter constants. With

a large condenser (greater than 2 mfd.) on the rectifier tube side of the filter (Fig. 1), the peak current *per tube* is roughly three times the load current *from two tubes*. With a large choke (greater than 10 henries) on the rectifier tube side of the filter (Fig. 2) the peak current *per tube* is approximately 1.5 times the load current *from two tubes*.

No attempt will be made here to include all the rectifier circuits sometimes used with this tube, but the accompanying table shows the ones most useful on single phase circuits. However, three phase circuits are often desirable when three phase power is available.

This table assumes the use of several well known transmitting tubes. For every case the maximum allowable plate voltage for c.w. use is chosen except for the UX-852 where both 2000 and 3000 volts are listed. The maximum safe input current to the transmitting tube is also assumed. A suitable rectifier is then shown for each transmitter. It is interesting to note that either two or four UX-866 tubes will supply every ordinary need for plate power for amateur transmitters.

The last two circuits are of special interest, where greater than 2000 volts is required. Here two tubes are used at each

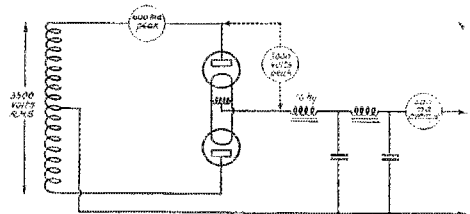

FIGURE 2. IN THIS CIRCUIT ARRANGEMENT, THE FILTER INPUT IS THROUGH A CHOKE

Here the peak current through each tube is only approximately one and a half times the average output current obtained from both tubes. A sacrifice in output voltage results, though, and this type of filter should be employed in cases where the output voltage may be low but where high output current is necessary.

end of the transformer so that full-wave rectification is accomplished without the use of a transformer mid-tap. As this connection makes full use of the transformer without increasing the peak inverse voltage, twice the usual voltage may be obtained. Two tubes act in series with this circuit, but this does no harm as the combined voltage drop is very low.

It is interesting to see how the choice of filter affects the output obtained. For instance, in supplying the UV-203-A tube, comparatively low voltage but high current

is required. Here a choke is used next to the tube to reduce the peak tube current at the expense of the voltage output. In the case of the UX-852, at 2000 volts, lower currents are required so that a condenser

mercury. Once in service, it should not be necessary to repeat this process.

When starting rectifiers using these tubes, at more than 2100 volts peak inverse the filament should be lighted for 30 seconds before plate voltage is applied. This may be automatically accomplished by a time delay relay in the plate circuit.

During life the bulbs will eventually darken. This is not an indication of the end of life and tubes should not be discarded on this account.

Strays

A new printing has been made of the Constitution and By-Laws of the A.R.R.L., revised to March 1928. A copy will be mailed upon request to any member of the League.

An idea of controlling regeneration in the short-wave receiver is suggested by W8AXW. A variable resistor of 50,000 ohms maximum is connected in series with a 250 µfd. fixed condenser, the two being shunted across the tickler coil. The rotating arm of the resistor is connected to the side of the coil going to the "B" battery so as to reduce "body capacity effects" This method, he states, gave as good control as the use of a "throttle" condenser with the added advantage that it caused practically no detuning when being adjusted.

"With two or more wires in a counterpoise, care should be taken that this arrangement does not act as an inefficient Hertz and absorb most of the energy from the set. In one particular station, the counterpoise was of such dimensions that it resonated to the wave on which it was desired to transmit. After taking down four of the six wires and testing about every piece of metal in the vicinity, the trouble was corrected by cutting two feet off each wire and using a four-wire counterpoise. This trouble was fought against for eight months before it was finally conquered."—W5AUR.

LAYOUT FOR AMATEURS

OSCILLATOR			RECTIFIER			RECTIFIER DIAGRAM	FILTER
TUBES	VOLTAGE	AMPERE	TUBES	TOTAL TRANSFORMER VOLTAGE	PLATE CURRENT PER TUBE		
UX-210 O	450	0.060	2UX-866	1250	0.090		120-VOLT DROP
UX-211 OR UX-103 A O	1250	0.175	2UX-866	3500	0.265		350-VOLT DROP
UX-852 OR UX-860 O	2000	0.100	2UX-866	3500	0.300		200-VOLT DROP
UX-852 OR UX-860	3000	0.100	4UX-866	3500	0.150		200-VOLT DROP
UX-204 A	2500	0.275	4UX-866	3500	0.400		500-VOLT DROP

NOTES.
 * 1000 ohms chosen as resistance of typical choke
 * Approximate values
 * Two tubes may be used in parallel without overloading rectifier

TABLE INDICATING VARIOUS USES OF THE UX-866

The above table indicates a suitable rectifier and filter arrangement for transmitters employing six different types of tubes commonly used by amateurs. It should simplify greatly the problem of picking the correct combination for most amateur transmitters. The cases treated are varied enough to allow other combinations to be determined without much guesswork being involved.

may be used next to the tube without exceeding the peak tube current limit. The result is a higher output voltage than in the former case. The only difference between the two cases is whether a choke or a condenser is placed on the rectifier tube side of the filter.

There are a few operating limits which might be emphasized here, although they are covered in the instructions accompanying the tube.

The filament of the UX-866 tube should always be operated at rated voltage. Less than this voltage may result in a high voltage drop across the tube with consequent bombardment of the filament and eventual loss of emission or even puncturing of the bulb. Greater than rated voltage will shorten the life of the filament by burn out.

A UX base is provided, the grid and plate terminals being anused.

During shipment the mercury may have become spattered onto the filament and anode and therefore when tubes are first placed in operation the filament should be lighted at normal temperature for a few minutes with no plate voltage applied to the tube in order to properly distribute the



An Examination of A. C. Plate Supply

Considerations Governing the Use of Self-Rectification in Our New Bands and Precautions Which Must Be Observed in Its Employment

By Ross A. Hull*

JUST as soon as the findings of the Washington Conference had seeped into our minds, reconciling us to the coming of a new phase of amateur radio, we came to think that the forthcoming restrictions were to spell the doom

of all self-rectified transmitters except those employing crystal control. And our sorrow at the thought was all the more acute on account of our knowledge that the self-rectified transmitter, as the result of its simplicity, was an important part of amateur station equipment. Our belief, however, now appears to have been premature. Experiment with a variety of self-rectified transmitters in the A.R.R.L. Laboratory has indicated that the signals from such transmitters

most certainly can fulfill the requirements of a "1929 type" signal if only the transmitters are designed and adjusted correctly. At the same time, the fact that the signals from these transmitters are so much more dependent upon careful design and operation of the equipment than is the case with d.c.-supplied sets makes it necessary to emphasize to the prospective user of self rectification the precautions which are to be so important. Very clearly, the lawful existence of the self-rectified transmitter must be dependent upon the extent to which amateurs are willing to

take care of the necessary refinement and adjustment of the apparatus involved.

The whole trouble rotates around the fact that the frequency of the output of the self-excited transmitter is influenced by the plate voltage—that in any such transmitter in which the plate voltage is alternating constantly from zero to maximum the attainment of a near-constant frequency is at once difficult.

The output frequency of a well adjusted crystal-controlled transmitter on the other hand, is not dependent on the plate voltage of the amplifier tube or tubes. Let us, then, use its performance as a standard against which to compare those of the other types of transmitters to be considered.

Assuming that the amplifier

of the crystal transmitter is a single tube supplied with an alternating plate voltage, its output, neglecting the side-bands, could be described as chunks of energy, all on one frequency, generated every other 1/120th second (on the positive half of each cycle of the supply frequency). This output could be indicated as the horizontal lines A of Figure 1.

In contrast to this we can consider the output of a single self-excited tube operating from the same plate supply. In this case the frequency is varied with each change in the plate voltage and, since the plate voltage is alternating continuously

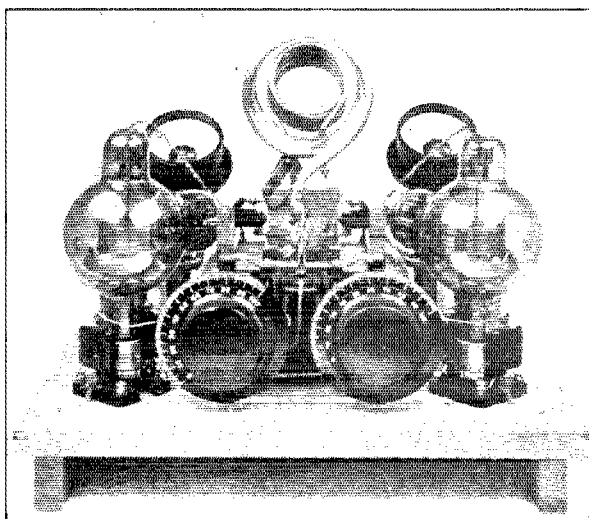

A SELF-RECTIFIED TRANSMITTER WITH A "1929 TYPE" SIGNAL

Fitted with a High-C tank and a means of matching the frequencies generated by both tubes such a transmitter is found to perform in the 1929 manner providing it is adjusted with great care. The grid condenser, not visible in the other photographs can be seen between the two tank condensers immediately under the wing nut of the coil mounting.

*Associate Technical Editor, QST. In Charge A.R.R.L. Technical Development Program.

the frequency of the output is never constant. If the transmitter is not particularly well arranged or adjusted we have found that the frequency change re-

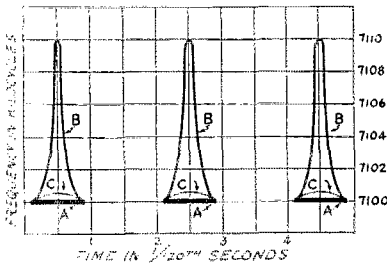

FIG. 1

sulting from a 100 percent voltage change can be of the order of 15 kc. on the 7,000-kc. band. As more representative of the average poorly adjusted transmitter we have shown this in Figure 1 as 10 kc. The curves B in that figure, again neglecting side-bands, represent the possible frequency output of this poor self-excited self-rectified transmitter. Whenever the tube is oscillating, its frequency is diving across a piece of valuable territory wide enough to accommodate half a dozen good amateur signals. The signal from the crystal-controlled transmitter, though it is broken into innumerable pieces $1/120$ of a second long, is all on the one frequency and in consequence the note in the receiver will be a musical one. This effect could be likened to playing a single note on a piano every other $1/120$ of a second. The note produced by the signal from the poor self-excited transmitter, however, cannot possibly have a musical character since the effect is then to be likened to playing every note on the piano during each $1/120$ second! It is hardly to be wondered at that the average self-rectified signal is a wretched splutter splashing itself over five or six times more territory than it has any right to occupy.

The Curves C in Figure 1 represent the output of a single tube, self-excited self-rectified transmitter in which a successful attempt has been made to reduce the effect of plate voltage changes over the frequency. In this case the frequency "flutter" resulting from the constantly changing plate voltage has been reduced to the order of 150 cycles—a condition which has been obtained without difficulty in practice—so

causing the frequency to "flutter" over only one hundredth part of the territory cluttered up by the poorly adjusted transmitter B.

The influence of the side-bands over the interfering capabilities of the signal is indicated in Figure 2. At A the oscillation frequency of the well adjusted crystal controlled transmitter is shown as a single vertical line occupying an insignificant amount of territory. On either side of it are represented the side-band frequencies produced by the modulation of the 60-cycle plate supply and its harmonics. The amplitude of the harmonics beyond the second is of a very low order and, for the purpose of facilitating the comparison, they can be neglected. We can, therefore, consider the crystal-controlled transmitter as emitting a signal 240 cycles wide. The diagram B is a similarly approximate representation of the output of the poor self-excited transmitter. In this case the fluttering oscillation frequency occupies a band of frequencies 10 kc. wide. The side-band frequencies exist

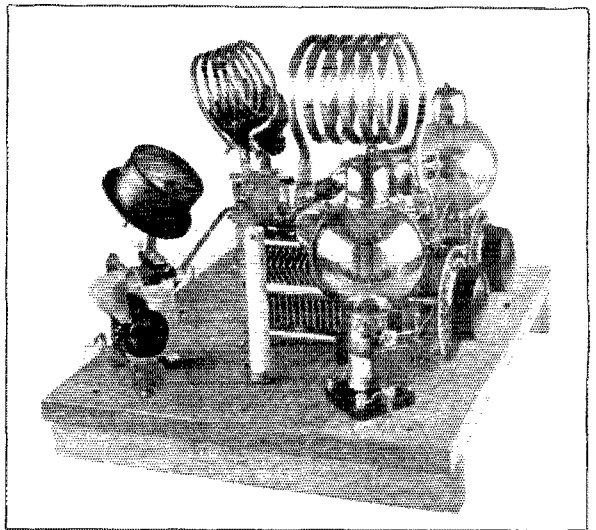

THE SELF-RECTIFIED TRANSMITTER IN PLAN

Showing, in particular, the mounting of the tank coil, the antenna coil and antenna condensers and meter and the radio frequency choke.

in this case also and since they follow the oscillation frequency in all its flutterings they can be shown alongside the outermost limits of the oscillation frequency by the single vertical lines. Again taking into account the side-bands produced by the fundamental supply frequency and its second harmonic we see that the signal from this transmitter occupies 10,240 cycles! Diagram C, representing the output of the "1929" self-excited, self-recti-

fied transmitter, shows the oscillation frequency fluttering over 150 cycles and carrying its side-bands as before. The territory occupied in this case is now but 390 cycles.

Complications are introduced by the use of full-wave self-rectification—when one tube is made to oscillate on one half cycle of the supply frequency and another tube on the other half. The chief trouble is that the two tubes in the average present-day transmitter do not generate the same frequencies.

Figure 3 provides a comparison of the output of a crystal controlled transmitter, a poor self-excited set and a good one—each employing full wave self-rectification. At A, as the standard of comparison, is indicated the output of the crystal transmitter. As before, the oscillation frequency is indicated by a single vertical line with the side-band frequencies similarly indicated on each side. In this case, however, the most important side band frequency is 120 instead of 60 cycles since both halves of the supply cycle are being utilized. Further, the second harmonic now produces side-band frequencies, at 240 cycles on each side. The territory occupied by the signal, again neglecting harmonics other than the

At B is seen a representation of the actual output of one transmitter built in the laboratory as a typically poor transmitter fitted with average tubes and poorly adjusted.

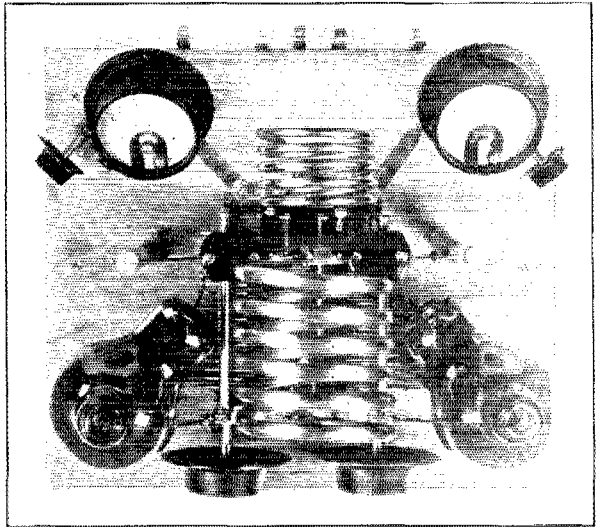

THE SELF-RECTIFIED TRANSMITTER IN PLAN
The symmetrical arrangement of the apparatus is apparent in this view.

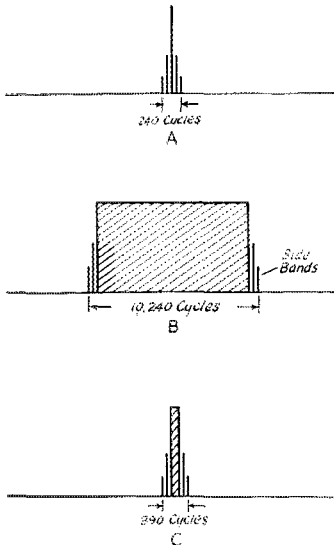

FIG 2

second, is now seen to be 480 cycles or twice that occupied by the half-wave transmitter.

The oscillation frequency produced by one of the tubes fluttered over the frequencies shaded by horizontal lines while the other tube, on account of differences in its characteristics, produced frequencies fluttering over the territory indicated by the vertical shading. In this case the signal, including the two main side-bands, occupied a band of frequencies 23,480 cycles wide! By fitting this transmitter with a High-C tank and by tuning it carefully the frequency flutter of each tube was reduced to the order of 200 cycles but the band of frequencies produced by each tube was still separated by approximately 1,400 cycles. The effect was that indicated at C in Figure 3. One tube was producing frequencies fluttering over the shaded area "a" while the other tube was emitting frequencies covering the territory "b". Each tube of course had its own set of side bands. The equivalent total frequencies covered in this case was 2280 cycles. Reconstruction of this transmitter to obtain mechanical symmetry and to permit the adjustment of the frequencies produced by each tube resulted in an output similar to that indicated at D. In this case the frequencies emitted by each tube were almost exactly similar, the width of the flutter was reduced to about 150 cycles, and the total territory cut down to the order of 530 cycles.

In all of this discussion, of course, the

representation of the character of the signals are approximate only and quite incomplete. They are intended only to bring out two points of major importance.

(a) That the side-band frequencies produced by a heavily modulated low frequency plate supply cause interference which is quite infinitesimal beside that resulting from the frequency flutter in the average present-day self-excited transmitter.

(b) That the full-wave self-excited transmitter is likely to cause more interference on the amateur bands than the half-wave transmitter since the two tubes usually produce two separate groups of frequencies, and because the important side band frequencies are twice as far apart.

At the same time it should be understood that the capabilities of the self-rectified transmitters in interfering with broadcast reception are not influenced greatly by frequency flutter and that of the two broadcast interference factories the half-wave transmitter probably would be the more formidable.

Let us now examine some ways and means of reducing frequency flutter and of setting the output of the two tubes to the same frequencies. The ideal method, of course, is to use crystal control with d.c. on the crystal tube and the a.c. on the amplifiers. No complaint could surely be issued against the signal from such a rig, correctly adjusted. With self-excitation the problem is a much more difficult one. The first move, we believe,

should be the arrangement of a particularly High-C tank circuit. In this way the efficiency of the transmitter will be lowered appreciably but the changes in output frequency resulting from variations in plate voltage will be reduced to such an extent that the loss of efficiency in the transmitter itself is compensated for by the

concentration of energy within a narrow band of frequencies and the resulting improvement in signal at the other end.

There appears to be some misunderstanding concerning the use of High-C circuits which has led to the suggestion that while High-C is satisfactory for tubes such as the UX-210 or UX-203-A its use with the higher impedance UX-852 results in excessive loss. The fact of the matter is that the L/C ratio which will give a certain degree of effectiveness in flutter reduction for a tube of high impedance or low capacity or both differs greatly from the L/C ratio of similar effectiveness for a tube of low impedance or high capacity or both. With any type of tube it should be possible to

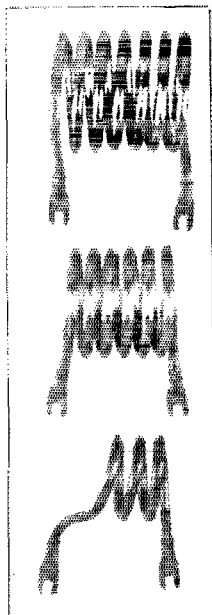

TANK COILS FOR THREE BANDS

The upper coil, used on the 2,500 kc. band consists of seven turns of copper tubing $\frac{3}{8}$ " outside diameter. The inside diameter of the coil is $\frac{3}{4}$ ". The center coil, for 7,000-ke. operation consists of six turns of similar tubing. The inside diameter in this case is $\frac{3}{4}$ ". The 15,000-ke. coil is of three turns with an inside diameter of $2\frac{1}{2}$ ".

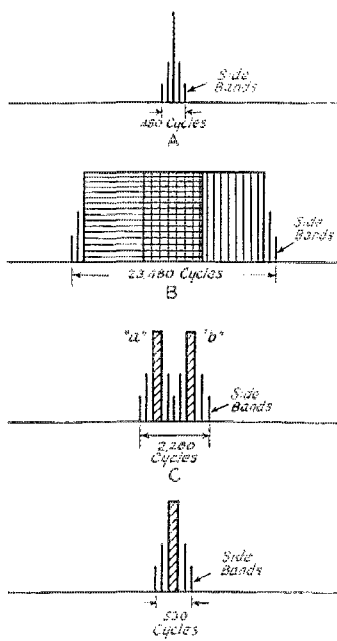

FIG. 3

provide an L/C ratio which will be effective to the same degree in improving the plate voltage-frequency characteristic with a similar sacrifice in transmitter efficiency. In short, there is a different optimum L/C ratio for each different type of tube. The exact ratio—the extent to which the High-C principle is carried—is, of course, greatly dependent upon the practical interest of the individual in the interference problem, and his willingness to avoid thinking in terms of antenna current. The amateur can rest assured, however, that the High-C principle has a thoroughly sound theoretical foundation. We hope to discuss it at some later date.

The particular apparatus chosen for the tank circuit in the transmitter illustrated consisted of copper tube inductances of the dimensions shown and two Type 199 Cardwell condensers connected in parallel. It will be noticed that the inductances are larger than those used in the UX-210 High-C transmitter*. In the construction of the transmitter this tank circuit is arranged between the two tubes in such a way as to permit almost exact symmetry in the grid, plate and filament connections. The complete cir-

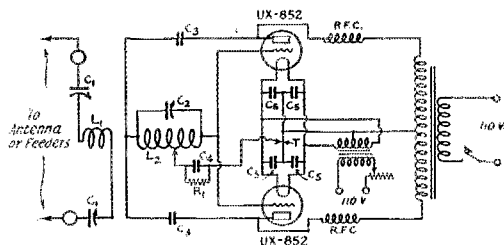

FIG. 4. THE CIRCUIT USED IN THE SELF-RECTIFIED TRANSMITTER

- C1*—350 μ fd. receiver type variable condenser.
C2—Two 350 μ fd. Cardwell transmitting condensers in parallel. A single condenser of about 500 μ fd. with sufficient plate spacing would be satisfactory.
C3—2,000 μ fd. fixed condensers (5000 volt rating)
C4—250 μ fd. grid condenser (5000 volt rating)
C5—2,000 μ fd. fixed condensers (500 volt rating)
R1—20,000 ohm grid leak.
L1—Antenna coil of copper tubing $\frac{1}{4}$ " outside diameter. 5 turns should serve for most antenna or feeder systems.
L2—Tank coils, illustrated and described elsewhere.
R.F.D.—160 turns of 28 gauge d.c.c. wire on wooden dowel rods $\frac{5}{8}$ " diameter.

cuit used is given in Fig. 4. It can be seen that it is similar to the self-rectified circuits which have been used all along. The only important difference is in the arrangement of the filament wiring to provide a means of adjusting the oscillation frequency of the two tubes to the same figure. Each tube is provided with its own pair of filament bypass condensers and the center-tap lead between them is made of a bare copper wire on which slides the filament clip return T, from the inductance. In the photograph of the front of the transmitter this lead can be seen between the two dials and at the by-pass condensers. The moving of the clip on this lead from the center position changes the frequency of one tube up and the other down so permitting them to be matched. Other schemes are possible such as the use of variable plate blocking condensers², individual variable grid condensers, small variometers in the grid or plate leads, or small condensers connected be-

tween grid and plate of one or both tubes. Many such schemes were tried in the experimental transmitters built but all of them had the disadvantage that any change in the constants in one tube circuit shifted the frequency of both tubes in the same direction. The frequency of the tube being adjusted moved faster than that of its mate but it was necessary to cover much territory before the frequencies eventually were brought to the same spot. The arrangement used in this transmitter is, admittedly, a crude one. It does permit the two frequencies to be brought into line, however, with much less difficulty than was experienced in the use of other methods.

The mounting of the remaining apparatus in the transmitter can be seen in the illustrations. The arrangement can, of course, be modified in a great many ways to suit the likes of the individual. The important point is just to preserve the nearest possible approach to exact symmetry in the endeavor to make wiring not common to both tubes, of the same length. If this is not done the frequency generated by the tubes may differ to such an extent that the provision of a satisfactory means of bringing them together would be very greatly complicated.

The construction of a half-wave transmitter need hardly be touched upon since the arrangement will be just that necessary for d. c. operation. The modification of the transmitter illustrated for half-wave use would merely consist of the removal of one of the tubes, its associate plate condenser and its radio frequency choke.

The tuning of a self-rectified transmitter is a similar process to that of adjusting a d. c. supplied transmitter with the one important difference in the case of a full-wave set that the two tubes must be adjusted to generate the same frequencies. In this work the use of a monitor of some kind is absolutely indispensable. With the average "1928" type self-rectified transmitter the frequency "flutter" was so great that the frequencies of the two tubes overlapped even if they were five or ten kc. apart. With a High-C transmitter in which the usual care has been taken with grid excitation, and antenna tuning the two separate groups of frequencies generated by the two tubes will be distinguishable in the monitor right up to the point when adjustment of the filament clip return merges them into one.

Our personal opinion, resulting from several weeks of intensive dabbling into self-rectification in all its forms, is that in cases where the station is so located with respect to broadcast listeners that interference with them is not a consideration the self-rectified transmitter is an entirely practical proposition just so long as the amateur is willing to build it correctly and maintain it in a

1. QST, August 1928, page 9.

2. QST, January 1928, page 32.

Coming! Governors-President Relay

ONCE again we have an opportunity for a worthwhile relay in which *all* amateurs in the continental United States could and should take part. The inauguration of the President of the United States takes place on March 4, 1929. In 1921 and again in 1925 we amateurs secured a message from the governor of each state addressed to the new President. We successfully relayed those messages to Washington, D. C., delivering them to the President right after his inauguration. At a later date the routing of each message, and full details of the relay including the handling of "service" messages to Headquarters concerning difficulties in securing messages and getting them off on schedule were reported in *QST*. This year we want to "put it over" again—and have some good fun and practise in relaying at the same time. Every station on the air will be looking for the traffic which will be originated simultaneously in forty-eight states (we hope all 48) and those stations most alive to the situation will have a chance to handle a good share of the traffic.

The relay will take place on the *third* and *fourth* of March 1929, beginning at 5 pm. E.S.T. March third and continuing through to 5 pm, E.S.T. March fourth, after which all the messages that have been received will be delivered at the White House. Get your station in readiness—and mark the dates up where you can't forget.

Each Section Manager in whose territory there is a state capital is designating an amateur to approach and secure a message from his governor addressed to President Hoover for transmission on this occasion. We are depending on each operator so designated by his S.C.M. to do his level best to get a message and see it started on its way properly. The messages will be limited to fifty words where possible and of course will be in the nature of congratulatory messages following the inauguration.

By the time this notice appears arrangements will be practically completed by the Washington Radio Club for a *continuous* watch to be kept at several of its different member-stations, and on the different frequency bands simultaneously. Most of the effort will be spent in covering the 3500 and 7000 kc. bands thoroughly, at the Washington end, although suitable periods of 14,000-kc. work are also planned in the tentative line-up which is expected to include W3NR, W3HL, W3GT, W3BWT, W3BKW, W3AGW and W3CDQ. W1MK at Hartford will also assist in collecting traffic for Wash-

ington or seeing it on its way as quickly and efficiently as possible. The regular W1MK schedules for March 3 and 4 will be set aside in favor of "general" operation, to enable the scheduled stations as well as the Headquarters station to take a full part in the relay. The stations of the Washington Radio Club have handled Governor-to-President traffic before and can be depended on absolutely to take care of everything sent in their direction. We are informed that these stations will call CQ GPR DE W3—each time before combing the hands for traffic Washington-bound. All stations are invited and requested to participate. Western stations should relay their messages to mid-west and eastern stations for QSP to Washington.

President Hoover may know that amateurs can do these things—but we want to once again put over the usual good performance and bring to his attention the fact that amateur radio is still *100% there!*

Following the relay don't forget to send complete and exact copies of the messages *you* handled showing the time received, the time forwarded, and both (or all) stations with which the message was handled. If you have comments on the relay please make them on separate sheets—the copies of messages with notations are most important of all to tell the tale, though. We want speed in relaying these messages—but first of all we must have *accuracy*. Everyone is asked to check his timepiece so the messages will correctly tell their story. Of course break-in operation will facilitate the message-handling work. Use it if possible. In any case, send no faster than the other fellow can copy, and you will thereby cut down on the time of relaying the messages which would otherwise be taken up by repeats. What we want to be able to do is to make a file of the messages turned in as originating in each different state, showing consecutive handling of this message through different stations as one reads the file from top to bottom. That means that we shall need copies from everyone handling or copying a message. Some of the messages travelled over more than one route during our last relay of this kind, too—and we want to be able to tell the whole story in *QST*. Please mail your copies and report promptly on March fifth. Don't forget to be ready for the messages which will go on the air at 5 pm E.S.T. March third (the same as 2 pm, P.S.T.)!

—F.E.H.

A "1929" Receiver

By Paul S. Hendricks*

THE FOLLOWING is a description of a receiver, built with some modifications on the general idea suggested by Mr. Hull's four-tube receiver described in *QST* for November, 1928. It may be of interest to those who would like to have a highly selective receiver for amateur work and still be able to listen to high frequency broadcasts and commercial stations which are found between the amateur bands.

The peaked audio amplifier provides excellent selectivity when a narrow band of frequencies is spread over the range of an

ordinary vernier type tuning dial, but to cover the entire range from say 3,000 kc. to 15,000 kc. would require perhaps three dozen coils. It would then be suitable for c.w. signals only, as the peaked amplifier ruins broadcast quality. Accordingly this receiver was provided with a switch to cut out the peaked audio stage and couple the output of the detector directly to the second

audio stage, also cutting in a bias battery on the audio stage allowing it to give good quality. This gives a considerable drop in volume when changing from the tuned amplifier to the untuned amplifier but due to the large volume obtained with the tuned stage it is usually desirable to reduce the output by means of the volume control. Then, when switching from tuned to untuned, the volume control may be readjusted and the signal level will not differ greatly. The amplifier switch may be seen in two of the photographs mounted on top of the audio frequency transformer, between the two tubes at the left end of the set. The connections are shown in Fig. 1., the switch being marked "tuned" and "untuned."

By complicating things a bit more another stage of audio might be added and the switching arranged to cut the extra stage in when the peaked stage is cut out, thus maintaining the volume level of the same order as with the peaked stage in and the volume control set at maximum.

The volume control R_5 is connected directly across the audio transformer secondary terminals and therefore may be used

whether or not the peaked stage is cut in. It may be noted that the two-megohm resistor, R_5 , which supplies bias to the last audio stage when the peaked stage is in use, becomes connected across the audio transformer secondary when the peaked stage is switched out. The effect is that of cutting down the amplitude slightly on the high end of the audio range. However, the effect will not be noticeable on good broadcast reception.

Another photo shows a front view of the receiver. The tuning dial in the center operates the condenser

C, Fig 1. The knob at the left operates the volume control and the one at the right, the regeneration control. The output jack is at the lower left and the filament switch at the lower right.

The resistance for regeneration control, R_5 , instead of being in series as usual, is connected as a potentiometer. This arrangement is apparently no more critical than

the usual method and the point of oscillation stays nearly in the same spot over the entire range for any one coil-condenser combination. The "B" battery drain due to the potentiometer arrangement is negligible, being less than one half mil with a 100,000-ohm potentiometer when using 45 volts on the detector. On this receiver the 45-volt tap for the detector works fine on all bands including the 28,000-kc. one. By connecting the "B" minus to the "A" minus lead outside the set, the potentiometer is automatically disconnected from the "B" battery when the filament switch is turned off.

The plate inductance L_1 for the peaked audio stage is, as used by Hull, a Ford secondary. A 0.01- μ fd. condenser across it brought the tuned peak to about 1,000 cycles. The coil is fitted with a wooden core and mounted on the sub-base with a wood screw from the bottom. This may be seen in one photo between the cable connector plug and the screen-grid audio tube at the rear left corner of the set. The 0.01- μ fd. fixed tuning condenser, C_1 , may be seen, edgewise, in front of the Ford coil and the cable connector plug, and above the Amperite unit. It is fastened to the circuit

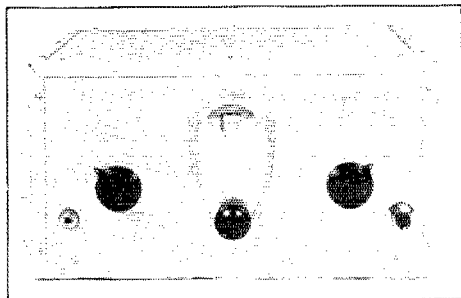

THE COMPLETE RECEIVER

*A.R.R.L. Technical Development Program.

wiring by long screws on which additional condensers may be mounted if it is desired to lower the tuned audio peak.

The various tuning ranges are obtained by plug-in coil-condenser combination units. They may be seen in the photographs and

fits into a G. R. jack and makes the ground connection to the low potential side of the circuit.

The coil-condenser assembly is really quite simple. The two units are joined by a pair of $\frac{3}{8}$ " brass strips which are drilled at each end to pass 6-32 brass machine screws. One end goes under the thumb nut on the condenser. The other end is bent at a right angle and screwed to the side of the coil form, with short 6-32 screws, for which the form had been drilled and tapped. These strips are attached to the grid side of the tuning condenser and the grid end of the tuning coil is soldered to one of them. The grid end of the coil also connects to the grid pin of the coil form permitting the connections to the r. f. tube plate and the detector grid to be made on the corresponding terminal of the UY socket. The secondaries are all wound with No. 20 enameled wire and the ticklers with No. 24 d.s.c. wire. The 3,500-ke. band coil has no spacing between turns and the rest of the coils have their turns spaced from one to three times the diameter of the wire. The adjustment, especially for the 7,000-ke. and 14,000-ke. bands, is quite critical. The method used in adjusting this set of coils was to wind them with a spacing of between one and two times the diameter of the wire and then remove turns until the coils were somewhere near the right size. The final adjustment was made by pushing the turns closer to each other or farther apart until the range was just right.

The coils were then doped with collodion or DuPont Household Cement, spread along several of the ribs on the coil form. It does not take much dope, even when only a narrow strip is put along three or four ribs, to throw the calibration off and it may therefore be necessary to make a slight readjustment of the end turn after the dope has dried. The tickler is placed near the open end of the coil form which is near the filament or low potential end of the tuning inductance. The ticklers, except on the 28-mc. band, are close wound and stuck at four points with dope. The tickler for 28 mc. is spaced about twice the diameter of the wire. It was found convenient to make the final adjustment for the 28-mc. band by sliding the tickler turns about slightly. With the tickler turns wound

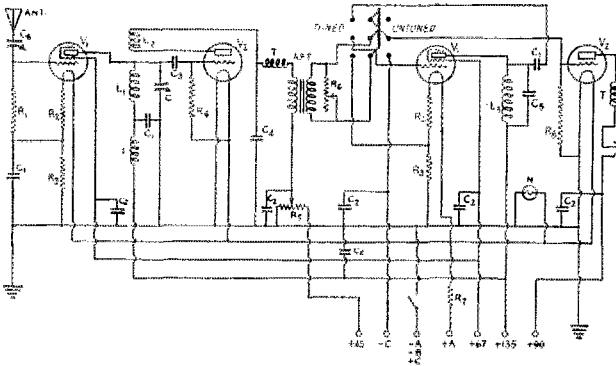

FIGURE 1

R1—50,000 ohms. "Grid-leak tube resistor" or r.f.c. (See text).

R2—10 ohms. Fixed resistor.

R3—5 ohms. Fixed resistor.

R4—8 megohms.

R5—100,000 ohm Frost variable resistor.

R6—200,000 ohm Frost variable resistor.

R7— $\frac{1}{2}$ -amp. Amperite.

R8—8 megohms.

C1—Pilot Midget variable condensers (see photos and text).

C2—0.006 μ f. Sangamo fixed condenser.

C3—1.0 μ f. Sangamo by-pass condensers.

C4—0.0001 μ f. Sangamo fixed condenser.

C5—0.001 μ f. Sangamo fixed condenser.

C6—0.01 μ f. Aerovox fixed condenser.

C7—0.0005 μ f. (50 μ f.) Pilot midget variable condenser.

L1—Plug-in inductances (see text).

L2—Tickler.

L3—Secondary of Ford spark coil.

T—R.f. chokes. Silver-Marshall, type No. 276.

AFT—Audio frequency transformer, Sangamo high quality type.

V1—CX-322.

V2—CX-301-A.

N—Dial lamp, as furnished on National drum dial.

J—Output Jack, single open circuit type.

G—To ground and metal cabinet.

the details of construction may be gathered. The coil forms are of the Pilot type which have five prongs that fit into a standard UY tube socket. Only four of the prongs are used. These coils have variously colored handles which had been removed to facilitate the connecting of the coil leads to the prongs. Unfortunately, they had not been replaced when the photos were taken. The tuning condensers are of the Pilot midget variable type which are available in a number of sizes of from five to twenty-three plates. For a given tuning range a condenser of approximately the right size was selected and then plates removed, when necessary, to obtain just the right amount of dial spread. One of the assembly screws forming the rotor mounting was removed and replaced by a General Radio plug. This

closely to each other it was found impossible to tune to a frequency higher than about 27 mc. By spacing the tickler turns it was readily possible to adjust the combination to reach 33 mc.

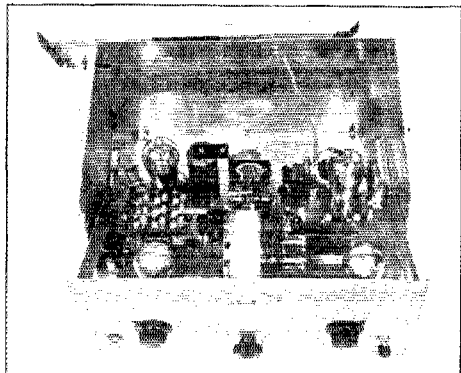

WITH LID OPEN

The manner in which the coil-condenser combination plugs-in is not clearly shown in the photographs. It consists simply of a pair of $\frac{1}{2}$ " by $\frac{1}{16}$ " brass brackets fastened to the metal sub-base, thus supporting the UY socket and a G.R. jack in such a position as to accommodate the coil-condenser combination as a unit. The coil plugs into the UY socket and is held in a horizontal position. The condenser stator is connected to the coil through one of the brass brackets holding the two together while the other side of the condenser makes connection to the rest of the circuit through a G.R. plug which slips into the jack mentioned above. The shaft of the condenser plugs into the hollow dial shaft and is fastened by means of the set screw.

In order to have the dial read in terms of frequency instead of wavelength it was necessary to set the dial at zero with the condensers at maximum capacity. The calibration is then held by always plugging in a combination under these conditions. A brass wing was stuck into the slot in the head of the set-screw on the dial shaft and soldered securely so that it is unnecessary to use a screw driver to tighten and loosen the condenser shaft when changing units. For convenience the set screw was moved half way around the shaft.

Incidentally, the dial lamp furnished with the National drum dials makes it easy to watch the scale and serves also as a tell-tale so that one is not so likely to leave the set turned on and find a dead "A" battery, some time later when a dash is made into the station to keep that next sked.

The small variable antenna coupling con-

denser, C', with its knob may be seen in one photo behind the plug-in unit and to the left of the r. f. amplifier tube. One corner of one of the stator plates is bent so that it touches one of the rotor plates when the condenser is turned to the maximum position thus forming a switch which short circuits the condenser and leaves the antenna connected directly to the receiver. For a given antenna and tuning range, the condenser, C', may be set and it is, therefore, not necessary to have its control on the panel. It is mounted well above the base, on an insulator which was originally the shell of an Aero r. f. choke. It has nearly the same dimensions of an ordinary tube base. A tube base would serve just as well if its prongs were removed. The condenser is fastened to the closed end and the shell is bolted to the base with two angle brackets.

The input to the r. f. tube is supplied with energy from the antenna by being connected across the resistor R' which may be seen in the right rear corner alongside the r. f. tube. One of the little Silver-Marshall chokes, type No. 275, was fitted with a pair of "ears" taken from an old grid leak and soldered to its terminals thus making it possible to plug in the choke instead of the resistor R'. That makes it a simple matter to change the input coupling from straight resistance to inductive impedance which usually gives better signal strength at the lower frequencies.

The use of r. f. chokes and by-pass condensers, wherever necessary, has made this receiver very smooth in operation with no dead spots and no tendency to howl at any point over its entire tuning range. The connections of the by-pass condensers are

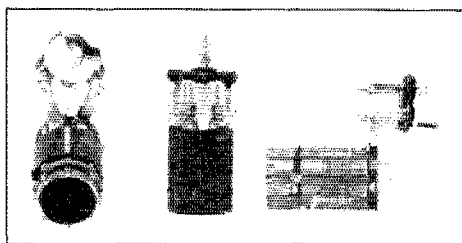

HOW THE COILS AND CONDENSERS WERE HOOKED TOGETHER

shown in Fig. 1. They do not show in the photographs as they are mounted on the under side of the metal sub-base. Their location is such that their terminals are directly beneath the points to which they connect above the sub-base. They are fastened to the sub-base in each case by two 6-32 machine screws and nuts, one of the

screws being attached to one of the condenser terminals and forming the ground connection. All of the battery wiring goes directly from the cable connector plug through a hole to the under side of the sub-base. The wires are then brought through holes in the sub-base to the proper terminals on the various pieces of appara-

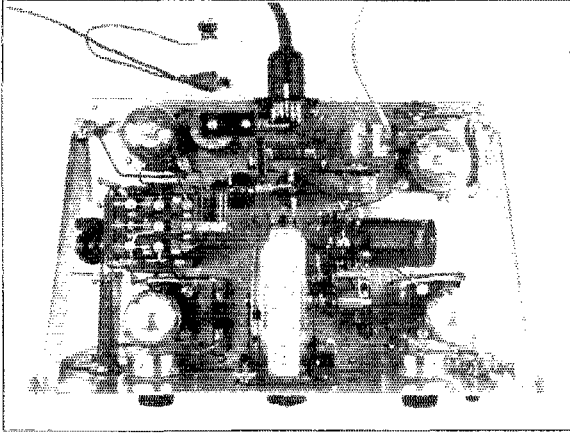

LOOKING INSIDE THE SET

tus. In order to insure against bad insulation where the wires come through the sub-base, the wire used is a light grade of high tension wire, such as is used in automobile wiring. It has rubber insulation over which is woven a very tough varnished fabric covering and it may be obtained in a variety of sizes at most auto supply stores. As can be seen in the photos there is very little wiring above the sub-base, there being only the wires connecting the high potential sides of the circuit. The apparatus is so arranged that leads are all short and direct.

The r. f. chokes in the plate circuits of the r. f. amplifier and detector may be seen mounted just behind the drum dial on the base. The choke in the plate circuit of the output tube can be seen behind the output jack and to the left of the switch which cuts out the peaked stage. The two tubes near the front of the set are; on the left the audio output tube and on the right the detector. Their respective grid-leaks may be seen mounted near the socket of each.

The all-metal shielding cabinet is not at all difficult to construct. The whole thing including sub-base and corner angles is made from 1/16" aluminum sheet which may be obtained in most tinsmith shops and is carried by some hardware stores. The tinsmith's shop usually has a machine which will cut the sheet accurately to size without

bending or distorting it. The corner angles were made by cutting one-inch strips and bending them at right-angles in the middle, with a tool designed for this purpose. The assembly of the cabinet which is bolted together with 6-32 machine screws and nuts may readily be understood from the photos. To settle the argument as to how the corner

angles were to meet, both ends of every piece have their corners clipped off at a forty-five degree angle. As may be seen, they all meet in the same manner and make quite a neat job of it. The sub-base is bolted to the panel with a piece of the same angle stock as was used in putting together the cabinet. Two more pieces running between points near the top of the front panel and the rear of the sub-base act as braces. Another piece across the rear makes the whole assembly a rigid affair mechanically and provides a firm support for the cable connector plug. The outside surface of the cabinet and corner angles was given a pleasing finish by "sandblasting" with a machine which is used in foundries for cleaning certain castings. The inside dimensions of the cabinet are: 7 1/2" high, 14" long and 9" deep. The sub-base is fastened to

the front panel so that there is a space of 1 1/2" between it and the bottom of the cabinet, thus providing ample room for the six by-pass condensers and the battery wiring. The volume control and regeneration control, which are mounted on the front panel, have a metal body to which the variable contact is connected. It was therefore necessary to insulate them from the panel which was done by making washers from a piece of 1/16" Bakelite. Ordinary sheet fibre or sheets of mica from a blown condenser may also be used.

All of the apparatus plus the front panel and sub-base can be slid from the cabinet by removing one bolt on each side of the cabinet and two screws from the bottom. On each inner side of the cabinet near the bottom may be seen two more pieces of the angle stock bolted in place to form skids for removing the assembly and to act as supports for the sub-base when the set is in position in the cabinet.

The seven battery connections are made with a Yaxley cable and connector plug which has just seven wires. The connector plug works very smoothly and apparently makes good dependable electrical connections. Since it is such a simple operation it is advisable to remove the plug whenever changing plug-in units or making

(Continued on Page 86)

Let's Get Serious

By Joe Gish

JANUARY 1, 1929, the magical date, came upon me yesterday. It caught me in the act of snooping around the amateur bands with a receiver in one hand and a transmitting lever in the other. There was much more of a change in the weather from 1928 to 1929 than there was in operation within the amateur bands.

"What are the limits of the bands?" "What does QSA3 mean?" Can you imagine that? Those quotations are genuine. Heard them myself. When questioned, the author of them admitted he had missed several *QSTs*. Heavens, tell me what *QSTs* he wants and I'll buy them and send them to him! If he is going to wander along in the coming year just picking up everything that is considered recent amateur practice from some ham who is doing what is right, there is going to be some punk operating from *that* station.

Do you know the new "Q" signals to be used from now on? Good. Seems as though darned few of the boys did. One fellow was overheard saying that he must QRT as he was QRW helping the OW. Taken literally that would mean that said ham had to stop sending because he was calling his OW. What? Doesn't sound logical but maybe this man knew what he was doing after all. Maybe he was calling her but he wasn't saying *what* he was calling her! Better get off that subject before we get in hot water.

Along about noon I was working some ham and ranting along about a new rectifier and I broke and gave him the GA. He came back with, "QRM QTA". Not to be outdone I shot back, "Whatdaya mean cancel radiogram, I was telling you something". And then what did he come back with but, "What are the new Q signals guess was my mistake." Can you imagine *that*? He expected I was going to spend the rest of the day sending the list of "Q" signals to him. Guess he wouldn't mind if two or three pages were taken up in *QST* every month to a repetition of the "Q" signals. This reading *QST* by looking at "Calls Heard", skimming over the rest of the book with a look of torture over your face is the bunk. Be observing and notice what is new and set forth every month.

Seriously now, let's get good and serious. This isn't just a kid's game. A fellow out in Oshgosh who never heard of short waves can't by a series of eliminations to a receiving set make a transmitter that will enable him to work the Antipodes. That is a thing of the past. Nowadays a person must be attentive to all the developments going on

in the gentle art and make use of them. Let's all of us be operators. That doesn't mean knowing the code from A to Z with no stumbling blocks but to be up on all recommended amateur practices. That word operators covers about everything too, as a good operator is one who can tune a transmitter and get the best results from the equipment at hand. Each and every one of us should be an operator and take pride in knowing that we are. This game holds forth much more for us in the future than it has in the past few years. Four years ago DX was the fad. Then, to the fellows who had been the first to accomplish this, the old note faded and what could they do? Now that is all at an end. There is more to work for. One can be improving constantly on his transmitter, receiver and aerial system, besides helping in the development of new frequencies. And right in that is there a huge assignment. In the past the receiver and transmitter were components in the word DX which were only given attention when they failed to give forth blasts or the antenna meter failed to wrap itself around the pin.

Let's take stock of everything that is good practice for an operator in the coming year and see for ourselves there is much more pleasure in the game now than in the past.

Silent Keys

It is with deep regret that we record the passing of these amateurs:

Ashley Dixon Jr., Portland, Ore., 7IT.
 Richard B. Chase, West Baldwin, Me.,
 ex1KX, and Cragmor, Col., 9FUY.
 Moses Bradford, Concord, Mass., 1IU.
 George R. Gerig, Portland, Ore., 7WU.
 Harold Hayes, Canajoharie, N. Y.,
 ex8BGY.
 Joseph A. Steinlage, St. Louis, Mo.,
 9CGN.
 H. K. Nelson, South Bend, Ind., 9FLU.
 Eric Colpus, Pontiac, Mich., 8CYT.
 William Richardson, Oakland, Cal.,
 6AJA.
 Edward E. Falkenback, Long Island
 City, N. Y., 2AKY.
 Richard Ballentine, Millvale, Pa., 8CXH.
 Joseph De Worth, Jersey City, N. J.
 C. J. McDonald, Dresser Junction, Minn.,
 W9GEY.
 Raymond W. Mahoney, Bangor, Me.,
 W1AVQ.
 F. A. Pepper, Los Angeles, Calif.,
 W6DMT.

A Cheap Radio Frequency Meter

By George W. Woster*

THERE are many who are employing receiving tubes for low power transmission and don't feel that they should spend as much for a radio frequency ammeter to measure the antenna current as they have spent for the entire transmitter itself but who would, nevertheless, like to have some idea as to how much current is flowing in the antenna circuit. A simple arrangement may be arrived at which will allow quite small amounts of radio frequency current to be measured and is shown in Figure 1.

The general idea is to insert a small flashlight bulb in the antenna circuit and adjust the amount of current flowing through it from the battery by means of the rheostat provided for the purpose until the filament just shows color. Either the current through it or the position of the rheostat dial (assuming the rheostat to be calibrated before-

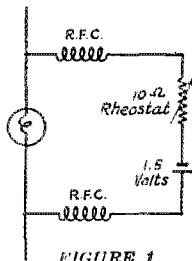

FIGURE 1

hand) is noted and the transmitter put in operation. The bulb will then grow brighter because of the additional amount of current flowing through the bulb. When the proper adjustment of the transmitter is obtained, the resistance in the lamp circuit is readjusted so that once more the filament just shows color and the difference between this reading and the previous one is the amount of radio frequency current flowing through the lamp.

It is, of course, necessary to use chokes to prevent the radio frequency current from by-passing around the lamp through the battery and rheostat circuit. Two r. f. chokes are provided and consist of 200 turns of No. 28 d.c.c. wire on a bakelite tube $\frac{3}{4}$ inch in diameter and five inches long. The complete outfit consisting of the chokes, a porcelain miniature receptacle, a Mazda No. 14., 2.5-volt spotlight bulb, a single flashlight cell and a 10-ohm rheostat may be assembled on a 3" by 3" panel in a small box.

With the specified bulb, the meter will measure r.f. currents up to 0.1 ampere and for currents between 0.1 and 0.2 amperes, one may use a Mazda No. 19, 1.25-volt bulb. The lamp alone will light up on currents larger than this and the rheostat cannot be used. The instrument is not particularly suitable for these higher ranges unless a lamp requiring a high current is used which will be a larger drain on the single cell, the voltage of which will vary considerably and the life of which will, therefore, be short.

The most satisfactory arrangement is to insert a low resistance milliammeter of 0-200 mil range in the battery circuit and find the difference between the two readings. However, for very approximate work, it is possible to roughly calibrate the rheostat dial to read in milliamperes through the lamp.

The resistance of the choke coils will be 2.8 ohms each and that of the bulb when the filament is showing a barely visible red coloring is approximately 2.5 ohms. The total resistance not including the rheostat is, therefore, 8.1 ohms. With no resistance of the rheostat in the circuit, the current will be 185 mils and with all the resistance of the rheostat in, it will be approximately 80 mils. At the quarter, half and three quarter points on the rheostat, the currents will be 95, 115 and 140 milliamperes approximately. This assumes that the voltage of the cell remains at 1.5. In practice, unless a large cell is employed, this voltage will vary under the loads resulting and the readings can only be considered as being approximate. The above current values are obtained with the No. 14, 2.5-volt lamp.

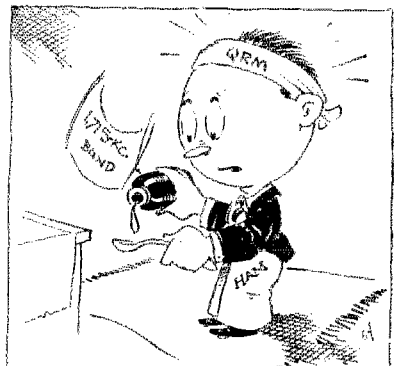

AN OLD TIME DRINK THAT'S BOUND TO REGAIN ITS POPULARITY
AS A BEVERAGE

*W9FKH. Reliance, S. D.

The Design of Inductance Coils

By D. R. Clemons*

In these days of reception and transmission at extremely high frequencies, one is apt to overlook many factors underlying the proper design of inductance coils purely because the normal inductance consists of such a small amount of material. A reading of this article should bring to mind many points of design that deserve the most careful consideration. Its general treatment of the subject will probably clear up many false impressions that seem to be prevalent among amateurs.—Editor.

THE UNIT of inductance is the henry. This unit was defined by the Chicago Congress in 1893 as the inductance "in a circuit when the electromotive force induced in this circuit is one international volt while the inducing current varies at the rate of one ampere per second."

James Clerk Maxwell seems to have been the first to treat self-inductance mathematically and prepared formulas for various coil shapes then in use. Gauss, probably working with Weber, seems to have calculated a number of cases of induction, but it is not generally known for what purpose this was done. Maxwell's calculations involve the mutual effects of parallel conductors, and in giving formulas for the various coil shapes, he also prepared corrections for wires of various cross sections and insulation thickness. Maxwell showed that unequal distribution of magnetic flux through the windings would reduce the self inductance of a long coil as shown in Fig. 1, where the solenoid, spiral, and multi-layer coil, although of equal wire lengths, have different values of inductance due to the mutual effects of turns being different. The solenoid having a flux distribution along a cylinder of considerable length must act through greater distances than for the compact coil C in which the flux is restricted to a very small volume of space in comparison, and the mutual effects are consequently much greater. As we shall observe later on, the spiral for windings not too deep takes characteristics of the solenoid both in its electro static and magnetic values, and for great spiral depths, has characteristics mid-way between the solenoid and compact type of winding. Formulas for calculations of self inductance are available in many standard publications. Such formulas are necessary in designing radio circuits. Tables of corrections for wire sizes and insulation thickness are also available. It is possible to calculate the greatest inductance for a given form or spool wound with various wires; best shape for a coil of given inductances; best shape providing a maximum inductance for a

given length of wire and so on. Let us examine the formula and factors governing the inductance of the solenoid:

$$L = \frac{0.03948 \times A^2 \times N^2}{b} = K \text{ microhenrys (1)}$$

The value 4π appears in formulas for inductance and refers the coil's area back to the spherical surface of the unit magnetic pole. The "unit pole" was considered as that strength which, when placed at the exact center of a sphere of 1 cm. radius, would produce one assumed line of force in each square centimeter of spherical surface. We find that a sphere of 1 cm. radius has $4\pi r^2$, or 12.57 square centimeters surface area, hence 12.57 or 4π lines must originate at the sphere center to bring about this

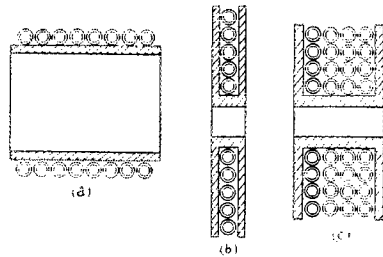

FIG. 1

condition. The above formula is in practical units by which inductance is expressed in microhenrys, therefore to carry the current sheet back to spherical measure involves $4\pi^2$

—hence the constant 0.03948 reducing 1,000 from dimensions to practical units.

The inductance of a solenoid varies in direct proportion to its dimensions when the number of turns remains the same; hence we find that making both the winding length and diameter twice greater will double the inductance. In coil designing, consideration of this is very important since it is often required to use very large or small wire, or provision may require greater separation between turns for coils subject to higher currents and voltages.

*317 Shenstone Road, Riverside, Ill.

Where very heavy cable may be necessary to carry several hundred amperes of high frequency current, the winding pitch, for insulation purposes, may be very great, and while such coils are several feet in diameter and possibly ten feet long, their inductance is of a value that may also be obtained on a tube only 1.5 inches diameter and 1 inch long, the wire for the small coil being of course, very fine. The smaller coil will be capable of handling small currents only. Thus a coil of given inductance may be of very large or small dimensions according to the physical and electrical requirements involved.

DISTRIBUTED CAPACITY

When a current of any magnitude moves through an inductance coil there is associated with it magnetic and electric fields which act together through the medium surrounding and containing the current sheet. If only one of these fields exists at a given instant there can be no current or flow of energy. Along the current axis of the entire winding there is an infinite series of potential points established as a result of the self inductance of the coil, which points are electrically related as a potential difference to all other points or group of points comprising the series. These points having position on the wire, are separated by a dielectric medium in which displaced currents may act, and cause transient currents in the medium each time any change of current magnitude takes place in the coil. Such displacement, due to the potential of self induction generated by the current stream acting through the conductor space occupied by the coil, permits energy to be stored in the dielectric. Any increase or decrease of potential brought about by the counter voltage of self inductance causes energy to be stored in the dielectric or returned to the circuit. Such dielectric action is always present and associated with every coil having reactance, the quantity of energy stored being largely governed by the geometrical distribution of potential (coil shape and type of winding) and the inductive capacity of the medium in which the action takes place. Since energy is so stored in the dielectric during transient periods, the coil has capacitance, and since this is obviously due to a distribution of potential, it is called distributed capacity.

Distributed capacity may be defined as that quantity which will satisfy the value C_0 in the familiar Thomson equation for frequency which we will write

$$\frac{1}{W^2} = L (C \times C_0) \dots \dots \dots (2)$$

or in terms of wavelength

$$\lambda_m = 1884 \sqrt{L (C \times C_0)} \dots \dots (3)$$

For Formula (3) the units are in microhenrys and microfarads. The distributed capacity of a coil may be very small or an enormous value depending on the design and arrangement of the windings. It is the writer's intention to point out the importance of the constant, C_0 , and to show its effect on the operative frequency of circuits; also to explain such details that may be helpful in determining its value.

In measuring the inductance of radio coils at high frequencies, it is customary to use a known value of capacity in shunt to the coil and measure the frequency of the circuit. A value for inductance is then obtained by a simple formula giving the apparent inductance of the coil which value is invariably too large, the error from the real inductance being dependent on the value of known capacity used and the frequency. When roughly obtained in this simple manner, the value for the coil is called the apparent inductance. We have used a known value for the capacity C ; no estimation of the distributed capacity was made, consequently the apparent value is too large since the capacity C_0 was equivalently in parallel with the condenser C as shown at A in Fig. 2. Suppose a common honeycomb coil of 100 turns is measured by this method using a condenser of 500 μ fd. known capacity; the wavemeter measures 1031 meters, so we obtain from the known values 599.3 phys. inductance which is the *apparent* value. The correct value of distributed capacity is 22.9 μ fd. for this one coil, hence the total capacity is $C \times C_0$ or 522.9 μ fd., which gives 573.0 phy. *pure inductance*. Here we find the error to have been over 4 percent for this normal illustration. Since this error may be involved in squares, it may be sufficient to create an enormous error in more complex frequency calculations. If the condenser capacity C is smaller or is small in comparison to the coil capacity, or should the coil capacity be very large—as it is for many types of coils—errors of 10 percent or more may develop. Hence, in all precision work, the distributed capacity should first be determined if the pure self inductance of the radio coil is to be known. For entry into precise formula, the constant C_0 and the pure inductance should be employed.

In designing frequency meters, coils calculated without consideration of the distributed capacity may not provide overlaps of frequency bands for the several coils used, therefore, it is common practice to employ the "trial and error" method, or to make estimations by considering but 30 to 80 percent of the condenser capacity available. By careful estimation of the distributed capacity of the coil it is possible to obtain precise overlapping of frequency

ranges. Owing to the coil capacity in any frequency meter, methods of interpolating in a calibration may cause considerable errors which increase as the capacity of the tuning condenser decreases. It is better to calculate certain values of frequency using the obscure constant C_0 than to depend on interpolation. Many excellent articles appearing from time to time on the mathematical design of coils for frequency meters and receivers have passed as negligible or entirely neglected any corrections for the coil capacity, although in many cases designs may consider coils of inherently large capacity. While it is true that the capacity is quite low for the spiral and solenoid suspended in *free space*, and is negligible providing the tuning condenser is *very* large, coils are never so used in free space. This is illustrated in modern broadcast receivers. Where one terminal is grounded to other apparatus, or where the coil is electrically related to a magnetic or electrostatic shield, the effective coil capacity becomes very large, sometimes increasing several hundred percent above the value C_0 for the free coil, and demands attention if correct calculations or final operation of the set, are to apply successfully. Errors in the expected frequency bands are large for moderate sized coils using condensers of less than 500 $\mu\text{fd.}$ and such errors become very large at higher frequencies approaching the coil fundamental, near which frequency terminal currents of the coil become nearly zero, causing very broad or impossible tuning on the highest frequencies of each band. This effect is due to a condition of parallel resonance, which occurs at or near the fundamental frequency as determined by the pure self inductance and distributed capacity of the coil. Where the apparent resistance of a coil is measured we find the coil resistance increasing rapidly as the coil fundamental is approached. By designing coils for a minimum of distributed capacity the effect may be greatly reduced; but until one has sound understanding of the factors governing magnitudes of capacity it becomes difficult to design coils of small capacities, for aside from simple theory and geometrical consideration, coil capacity may be considerably affected, by conditions external to the coil.

The features which give to a coil a high or low distributed capacity are not generally understood, and unless direct experimental work is done on many coils of various types of winding, it is difficult to approximate coil capacity. While determination of the magnetic flux density acting in the dielectric is purely a mathematical problem, exact calculations or even approximations of the electrostatic component are especially dif-

ficult due to the complex nature of the dielectric medium and the uncertainty of the manner in which the potential is distributed along the coil winding. The potential node may shift position in a mounted coil. There seems to be no generalized formula for the calculation of coil capacity. Probably the most conclusive mathematical analysis has been reported by G. Breit who gave mathematical processes and formulas for calculations of coil capacity of cylindrical windings. In general, the report deals with coils ungrounded and in free space;

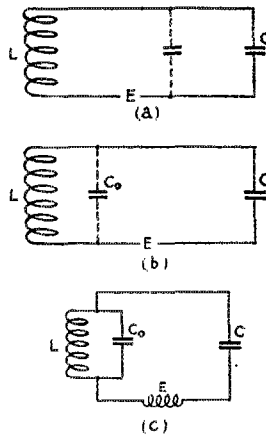

FIG. 2

coils with one terminal grounded, and coils within elliptical shields or before flat plates. For a cylindrical coil in free space unshielded and with coil center grounded, Breit gives the formula

$$C_0 = 0.06952 K L \mu\text{fd.} \dots \dots \dots (4)$$

where L is the perimeter of the coil and K the inductive constant of the medium subject to the electric flux. This is for coils of cylindrical windings and shows fair agreement with values experimentally obtained when applied to very short air insulated coils. It may be satisfactorily applied to solenoids of short length, C_0 being approximately equal to $0.44 \times r \mu\text{fd.}$, where r is the coil radius in centimeters. To illustrate: An 11-turn, single-layer coil 8.2 cm. in diameter and 17 cm. long gave a measured capacity of 1.750 $\mu\text{fd.}$ and a calculated value of 1.792; a 36-turn, single-layer coil, 12.6 cm. in diameter and 3 cm. long gave 2.457 and 2.751 $\mu\text{fd.}$ respectively for the measured and calculated values. For a coil of very large diameter, while actually measuring 8.064 $\mu\text{fd.}$, calculations gave a lower value of 5.76 $\mu\text{fd.}$ The above formula (4) may also be applied to spirals of small winding depth.

The distributed capacity is too small when calculated from the coil geometry alone is too small, the error becoming larger as the winding length increases. Moreover, by examination of the formula (4) we find the constant K of the medium through which the electric flux acts: As dielectrics in the region of greatest flux density are usually compounded and of divergent nature, it is quite impossible to give to any common coil a correct value for the term K. For a short coil of bare wire in free space, the formula is very accurate and yields well; or where the coil, having a bare exposed winding, is entirely submerged in

voltage is impressed on the oscillatory system containing the coil under observation. If an inductance coil is freely suspended in space the frequency at which the currents will have maximum amplitude in it is determined by the self inductance and distributed capacity of to the coil or

$$f = \frac{1}{2\pi \sqrt{L C_0}} \dots \dots \dots (5)$$

where L and C₀ are in henrys and farads respectively. The variation of high frequency resistance of the copper is according to the frequency. Due to the coil resistance and to some radiation from the coil, there will be a very slight variation in resonant frequency from that obtained by formula (5), but since both radiation and coil resistance effects are almost negligible in affecting a circuit's frequency at radio frequencies, the frequency of oscillation is very closely obtainable by formula.

If an inductance coil is connected to a condenser as shown in Fig. 2A, the apparent coil resistance will depend largely upon the frequency and the manner in which the potential acts on the coil. If the potential is induced into, and acts directly in the coil L as at E, the coil capacity C₀ acts in parallel with the condenser C, and at all lower frequencies to which the coil may then be tuned, resistance is due mostly to the conductive properties of the copper winding, but as the resonant frequency increases with the reduction of the condenser capacity C, the coil fundamental is approached at which frequency the effective resistance becomes very high for all small values of the condenser C. As this limiting frequency is approached, the coil terminal circulating current becomes nearly zero although it is large, near the coil center; but for all lower frequencies not too close to the fundamental, currents become more uniform through the coil. To be exact the frequency of such a circuit must include the obscure coil capacity C₀ and is equal to

$$f = \frac{159,200}{\sqrt{L (C + C_0)}} \dots \dots \dots (6)$$

where the units are expressed in microhenrys and microfarads.

Where an inductance coil is located in such position that the potential is impressed upon its terminal as shown at B in Fig. 2, the coil capacity acts in shunt with the inductance independently from the condenser C and establishes the effect of parallel resonance as illustrated in 2C. In this case the combination L and C₀ becomes resonant near the coil fundamental with the

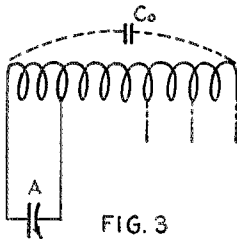

a dielectric of known inductivity in such manner as to completely enclose the electric flux in this new medium, the coil capacity will then be found to vary as the constant K of the new medium; but for coils in which the entire dielectric subject to the electric displacement is of a compound nature and of arbitrary position, it is quite impossible to accurately estimate the value for the constant K. Such dielectrics as cotton, silk, enamel, and other insulating materials; tubes for coil mountings and compounds of laminated bakelised paper; insulating varnishes and oil, all have variable constants of about 2.00, but this value cannot be used and satisfy K. An increase of capacity due to adjacent dielectrics cannot be calculated directly unless this material occupies the entire electric field of the coil, and obviously, in spirals and about cylindrical windings, the added material may occupy only a small portion of space through which the field acts. There is no direct or satisfactory mathematical method of calculating the final capacity of mounted coils subject to the several effects which may act increase the value of distributed capacity.

RESISTANCE

The four circuit parameters which we must consider are; resistance, inductance, capacity and leakage. These combine to make up the effective resistance. The effective resistance of a coil at radio frequencies depends largely upon the frequency and upon the position of the coil in the circuit, particularly on the point at which the

potential acting at E, and the effective circuit resistance to circulating currents becomes enormous with nearly impossible tuning at or near all higher frequencies. These effects are often found in circuits provided with loading inductances or coils provided with taps. A potential applied at E encounters the self inductance of the coil L, raising the potential along the coil, permitting displaced currents to act in the dielectric of the coil capacity C_0 ; which capacitance energy is subsequently returned to the circuit with negligible loss. At or near the resonant frequency of the coil, these local circular currents in L and C_0 reach a value often quite equal to currents through the condenser C and coil E. If a parallel circuit of zero resistance were in this position, the counter voltage of self inductance would increase with the local coil current until it became exactly equal and opposite to the impressed voltage in E, and the impedance of the coil L with C_0 would be infinite with respect to the external circuit containing C, while the terminal current then being zero would permit no current whatever to pass through the coil L from the condenser C. But the imperfect conducting material in the winding, together with an imperfect dielectric about the coil with some slight radiation from the coil causes a loss of power which may be assumed constant with a given frequency, hence the only current that may pass the coil L at the resonant frequency is that current required to maintain the power loss due to coil resistance. At radio frequencies, the copper resistance of a coil

resistance to terminal currents at resonance of the coil will be enormous. Actually, with zero resistance, neglecting transient periods of very short duration required to establish currents in L and C_0 , no current whatever would pass the coil terminals. This is the theory of the wavetrap: The trap inserted

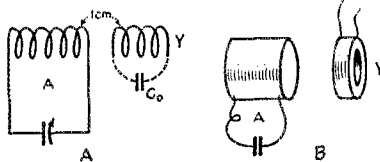

FIG. 5

in the antenna circuit is tuned to resonance with the station to be eliminated; the effects mentioned take place and choke out the undesired frequency. Obviously, then, to be efficient and completely stop this one frequency, the trap should have the lowest possible copper resistance, requiring special stranded cables known as Litz; a very good condenser; perfect insulation, and no high resistance metal in the coil field would be requisite for this condition. Such a circuit would tune very sharply and would stop but a very narrow band of frequencies while all others would pass the trap.

If parallel resonance effects are present in receiving sets there will be frequencies near which band sharp tuning is practically impossible and signal frequencies become weak. To cover a large frequency band a large coil may be wound and provided with taps at various positions as shown in Fig. 3 in which a small portion of the coil used with the condenser C forms a tuned circuit at A. Now, this coil is quite large and has inherent capacity which gives to the coil a fundamental frequency in free space, and this frequency becomes lower by the addition of several taps and by grounding the coil end to extra apparatus forming the circuit A. Let us suppose the entire coil, when wired as shown, to be resonant at 750 kc., and that the coil is inductively coupled with the antenna and has a potential induced in it near the section A. For various impressed frequencies we may adjust the condenser C and develop considerable signal currents in the circuit A, but on tuning through and very near to 750 kc., the entire coil becomes resonant, establishing a complex parallel effect in the circuit A making sharp tuning utterly impossible and signals quite inaudible near the fundamental frequency; but the system again becomes tunable in the circuit A at all lower frequencies. Near the fundamental, terminal currents in the circuit A become nearly zero because the current anti-node of the in-

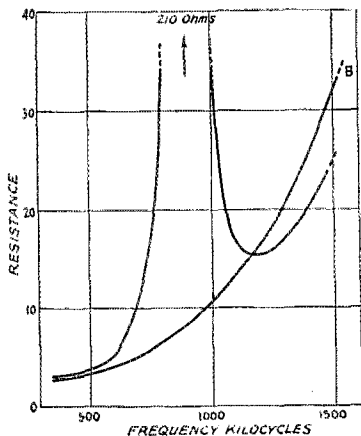
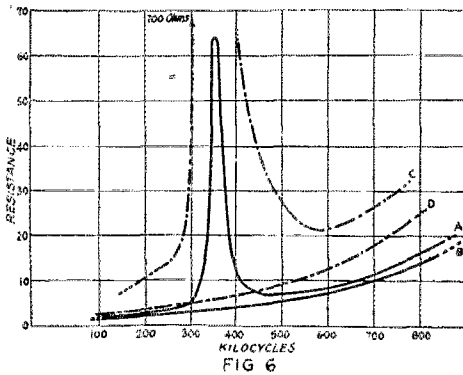

FIG. 4

may be large, and at the fundamental frequency of the coil L, some current will pass to maintain the loss, but due to the parallel resonance effects, the effective

ductance coil has shifted beyond the circuit A, hence the terminals of the tuned circuit A do not enclose a potential which had been produced at all other frequencies. In this manner a parallel resonance effect at or near the fundamental frequency make the set not only untunable but also very sensitive to any static changes taking place in the entire coil field. Such undesirable effects are equivalent to a loss of energy as the effect tends to reduce the usual energy acting in the circuit A, so by expressing the entire phenomenon as resistance we have a method of showing current magnitudes at various frequencies.

Two solenoids were made up to demonstrate this effect: The circuit A of Fig. 3 was to be measured at various frequencies



by the resistance variation method. The potential is induced in the section A by coupling to a 10-watt oscillator. This coil, illustrated as B in photo A, has 144.0 μ h. inductance included in the circuit A and measured as follows: As the frequency approaches the coil fundamental, the resistance in circuit A increases gradually to 5 ohms at 600 kc. Then on approaching 900 kc., due to parallel effects described, the resistance suddenly increases to 210.0 ohms, again falling to 15.5 ohms at 1,200 kc. and thereafter increasing in a normal way with the frequency as shown in Fig. 4. At any frequency near 900 kc., the critical effect of the capacity C_0 was so pronounced that anybody moving within several feet of the coil was sufficient to detune critical adjustments—which adjustments were made by insulated rods several feet long. This is described to show the extent to which the electrical component may be altered by objects even remotely related to the coil. Such variations of capacity are considerable in very long solenoids due to various modes in which currents may be distributed.

Obviously, if the coil capacity should be

removed, parallel resonance effects would be destroyed. This can be brought about by shorting the unused part of the coil. It might seem to the reader that shorting the unused part of the coil greatly reduces the self inductance and increases the resistance of the inductance included in the circuit A, but this change is almost negligible, particularly if the unused portion of the coil is large. In this instance, the impedance in the shorted portion is between ten to thirty thousand ohms for the frequencies used in this experiment, hence, negligible currents cause but insignificant loss in the shorted part of the winding and have but little reaction on the oscillatory circuit. In the second curve B of Fig. 4, we have the effective resistance of the system A with the unused turns shorted by a heavy wire. The resonant condition is completely destroyed and little change of resistance is observed over the useful band of frequencies covered by circuit A. The slightly greater increase at very high frequencies is due mostly to stray capacity of the shorted part which tends to increase the capacity of the system.

There may be a second inductance coil at some distance from, but inductively related to, the coil in which useful oscillating currents are generated, and if this isolated coil has a free period, it may react and seriously affect the operation of the coil in use. Such a coil might be a loading coil having a position as shown in Fig. 5A, and at B. This coil at Y becomes energized at its fundamental, reacting mutually on the tuned circuit A, increasing the latter resistance according to the inductive relation between them. To demonstrate these effects a coil was tuned with a variable condenser forming the useful circuit A in Fig. 5a. The coil at Y was a Litz-wound coil of square cross section, and with the terminals open the resistance of circuit A was measured and is shown as Curve C in Fig. 6, for which the coil windings were separated 1 centimeter apart, giving above 700 ohms to circuit A at the resonant frequency of coil Y. The coil Y was next shorted and, of course, effects of distributed capacity in it were destroyed, hence it developed impedance due to inductance, its value being above 13,000 ohms. Therefore, currents in the coil Y are stopped and reaction between the two coils is then negligible as shown by the curve D for which the resistance of the coil A increased normally from 5 to 18 ohms at these previously critical frequencies. Coil Y was next removed 6 centimeters distant from the coil A, and when resonant, gave the curve A in Fig. 6, which shows an increase to 64 ohms but quickly returned to 7 ohms at 500 kilocycles; then, by shorting the resonant

(Continued on Page 30)

The UV-861

A Screen-Grid Tube for the High Power Amateur Transmitter

By Harold P. Westman, Technical Editor

SOME months ago we described a 75-watt screen-grid power amplifier tube known as the UX-860. The UV-861 has in relation to this tube been correctly designated for most assuredly it goes the 860 one better—and a good one at that! To begin with, its rated output is 500 watts, seven times that of the 860 and its size dwarfs practically all other glass-envelope air-cooled tubes with which the amateur is familiar. Even the 204-A, long considered a Jumbo, seems but a trifle by its side.

The 861 is designated primarily for use as a radio frequency power amplifier in transmitting circuits. As such it requires no neutralization to prevent self oscillation because the employment of the fourth element, a screen-grid, reduces the effective capacity between the control-grid and plate to but 0.50 μ fd. For stable operation though the external circuit capacity should be kept as low as possible.

As can be seen from the photograph of the tube, it partakes of the appearance of both the 860 and the 204-A. In addition to the three large arms such as is found on the 860, there is a fourth arm of somewhat smaller proportions which acts as a support for the plate assembly. The two opposing large arms are based much as is the 204-A although the circuit connections are not the same as for that tube. The two horizontal arms support the plate which is mounted upon four metal rods. Two of these rods are sealed into a stem in each of the arms. Neither of these arms is based

and the plate lead which is made up of two heavy twisted wires is taken through a seal in the larger arm. These plate leads should be twisted to prevent heating in one. This type of tube construction allows separate stems and seals to be employed upon which the various elements are mounted. The result of this greater spacing is shown in the very low capacity and high insulation resistance between the elements which makes the structure so suitable for high frequency operation.

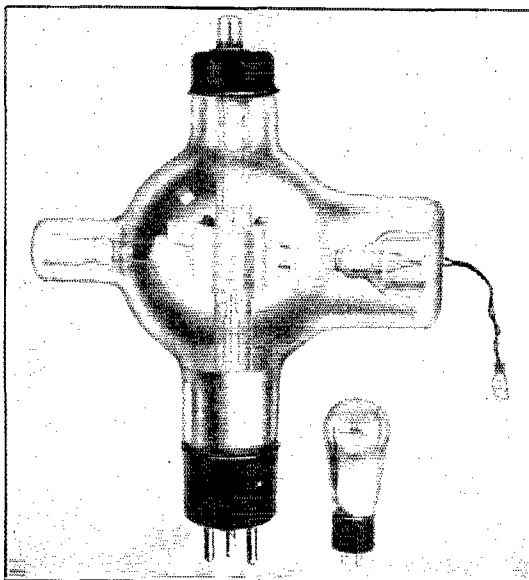

THE UV-861

The tube alongside of it is not a 204-A as one might suppose; it is a UX-210. A further idea of its size might be realized when it is considered that this tube is several inches too long to be accommodated in the mounting for a 204-A. It truly is a he-man affair!

FILAMENT

As in practically all the power tubes being manufactured today, a thoriated tungsten filament is employed. For normal operation a current of 10 amperes at 11 volts is required to heat it to the proper temperature. It is recommended that it be operated at a constant voltage as under this condition maximum operating life will be obtained. The running of the tube with less than normal voltage is not desirable as it may result in a loss of emission because the electrons are being absorbed at a faster rate than they are being

supplied to the surface of the filament from its interior. The use of too high a filament voltage will cause a rapid reduction in its diameter and the life will be ended by burn-out.

The filament is supported by a single centrally located rod and because it is constructed in the shape of a double spiral or helix, it requires no tension spring whatever. This obviates the necessity of an additional support from the opposite end of

the tube in the stem of which is mounted the control grid. Such an additional support, if needed, would tend to increase the capacity between the two elements as well as reduce the resistance between them.

REACTIVATION

Fig. 1 shows the current vs. voltage characteristics of the filament. Two other curves taken for values of +5% and -5% are also shown. In Fig 2 values are plotted for the emission and filament efficiency.

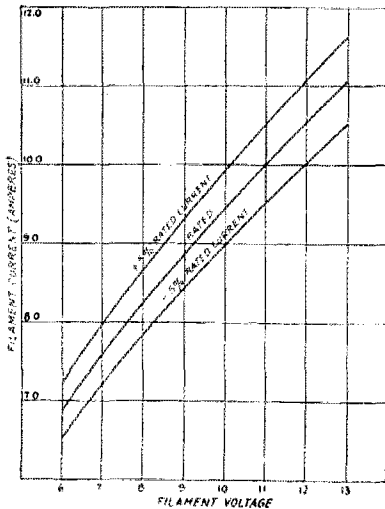

FIG. 1. FILAMENT CHARACTERISTICS ARE GIVEN FROM WHICH THE FILAMENT CURRENT FOR ANY FILAMENT VOLTAGE MAY BE OBTAINED

For convenience in calculation, curves are shown for a 5% increase and 5% decrease from the rated values.

The total emission at the rated voltage is approximately 10 amperes and the efficiency at this point is roughly equivalent to 100 milliamperes plate current per watt of filament power.

A loss of emission may be the result of an overload, insufficient filament voltage or such abuse and if no large amount of occluded gas has been driven out of the elements, it is possible to reactivate the filament by operating it at the rated voltage for ten minutes with the other electrodes free. The reactivation process may be hastened by raising the voltage to 13. Under no conditions should higher voltages be employed. The tube should be so mounted that the filament is in a vertical position; either end may be uppermost.

Whenever possible, alternating current should be used for filament heating with plate and grid returns made to a center tap on the filament heating transformer.

If it is absolutely necessary to operate the filament from a direct current supply, the plate and grid returns should go to the positive leg of the filament. The filament terminates in the two prongs of a mounting similar to a 204-A grid base which caps the lower arm of the tube.

CONTROL GRID

The control grid is cylindrical and surrounds the filament. It is mounted upon four longitudinal rods and is of a comparatively coarse mesh. The effect of the control-grid voltage upon plate current for various values of plate voltage is shown in Fig. 3. From this curve it may be seen that the plate current changes but slightly for large changes in plate voltage. In Fig. 4, the effect of the control-grid voltage upon the plate current is shown for several values of screen-grid voltage and a plate voltage of 3,000. In operation the control-grid bias may be obtained by means of either a biasing battery or grid leak resistor. The control-grid terminates in what would be the plate terminal of a 204-A base.

PLATE

The plate is circular and is equipped with six generous fins or wings which allow rapid dissipation of heat and in consequence, a

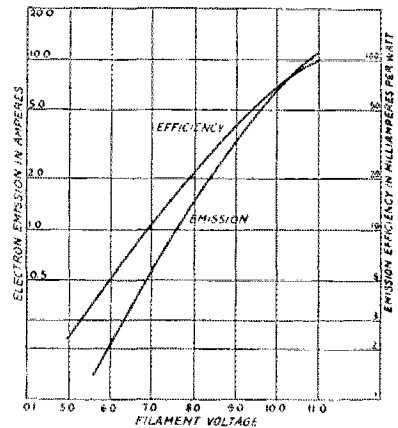

FIG. 2. THESE CURVES SHOW THE AMOUNT OF EMISSION AND THE EFFICIENCY OF THE FILAMENT AS AN EMITTER FOR VARIOUS VALUES OF FILAMENT VOLTAGE

At the operating voltage the total emission is about ten amperes, the efficiency being equivalent to 100 milliamperes of plate current for each watt of heating energy.

greater output rating than could be obtained with a plain plate. The plate dissipation should never exceed 400 watts which corresponds to a cherry red coloring. While the normal plate voltage is 3,000, it may be operated at as high as 4,000 volts

when used as an oscillator that is not being modulated. The plate dissipation under these conditions remains the same and no coloring brighter than a cherry red should be considered as indicative of proper operation. Due to the high allowable dissipation, free circulation of air about the tube is essential. When being overloaded, the use of forced ventilation is recommended to increase the factor of safety against breakdown. The tube should never be mounted in a cabinet or box restricting ventilation nor should it be placed in contact with anything or be subjected to spray or drops of liquid.

SCREEN-GRID

The screen grid is mounted just within the plate and consists of a cylindrical helix of wire supported upon four rods fastened to collars that are clamped to the stems of the based arms. The screen runs the full length of the tube, effectively shielding the plate from the other elements. It terminates at the grid pin of the 204-A base. A high capacity between the filament and

The d.c. screen voltage should be kept as low as practical and is normally about a quarter of the plate voltage. It is desirable

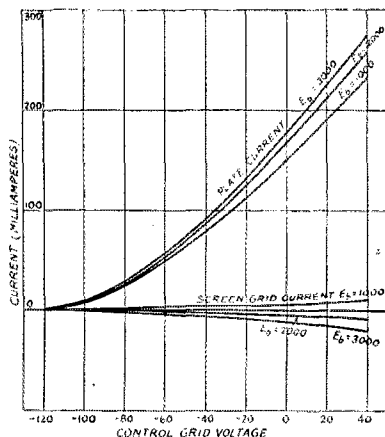

FIG. 4. THESE CURVES WERE OBTAINED WITH A PLATE VOLTAGE OF 3,000 AND SHOW THE EFFECT OF THE CONTROL-GRID VOLTAGE UPON PLATE AND SCREEN CURRENT FOR THREE VALUES OF SCREEN POTENTIAL.

As may be seen, the screen voltage has much more effect upon the plate current than has the plate voltage, curves for which appear in Figure 3. The screen current is extremely small or negative over the range of control-grid voltage plotted.

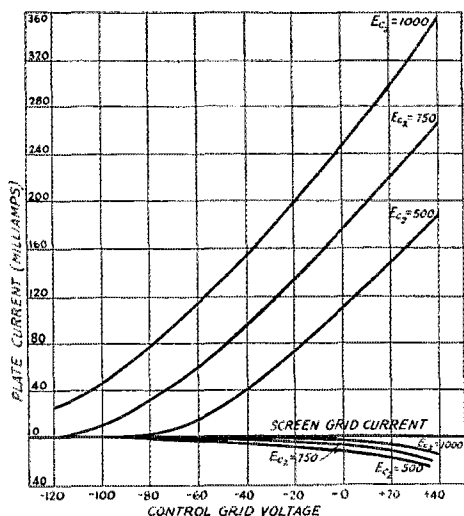

FIG. 3. THE EFFECT OF THE CONTROL-GRID VOLTAGE UPON THE PLATE CURRENT FOR THREE VALUES OF PLATE VOLTAGE IS SHOWN HERE

These curves differ from those obtained with a triode chiefly in that the increase of plate voltage has but a small effect upon the plate current. The screen voltage in all cases was 750 and a negative screen current is obtained at plate voltages of 2,000 and 3,000 for all values of control-grid voltage less than about 100 volts negative.

that this voltage be obtained from the plate supply. A potentiometer arrangement will be most satisfactory. Under no conditions should the plate voltage be removed while the screen voltage is still applied as the screen will then act as the plate of a three-electrode tube and the screen current will increase greatly resulting, perhaps, in its destruction. The amount of energy dissipated in the screen should never exceed 35 watts which, as in the case of the plate, corresponds to a cherry red coloring. Figs. 3, and 5 show values of screen current under various conditions; those proper for normal operation give little or no current in this circuit.

A tabulation of the general characteristics is as follows:

- Filament volts 11.
- Filament amperes 10.
- Normal plate volts (d.c.) 3,000.
- Max safe screen dissipation 35. watts.
- Max safe plate dissipation continuous 400. watts.
- Rated output 750. watts.
- With a filament voltage of 11, a plate voltage of 3,000, a screen voltage of 750 and a control-grid voltage of 0, these values are obtained:
- Amplification constant 300.
- Plate impedance 133,000. ohms.
- Mutual conductance 2.25 ma/v

screen grid is desirable and a large by-pass condenser should be connected across these elements close to the tube. The screen should be at ground potential as far as radio frequency currents are concerned.

(Continued on Page 88)

The UV-861 In Action

Concerning the Big Brother of the UX-860, Screen-Grid Tube

By Clark C. Rodimon*

THAT the four-element tube has continued further into the amateur world is evidenced by the appearance of the UV-861. With the introduction of the UX-860 some six months ago we felt that our fondest dreams of obtaining suitable tubes for power amplifier operation at high frequencies were to be realized.

Unfortunately, the man with the 204-A was not taken care of and he had the choice of giving up either the use of a screen-grid amplifier tube or a considerable amount of output power. As one simply hates to see a 204-A lie around idle while a much smaller tube is being operated, the usual result was to give up the pleasures of the use of a screen-grid tube. However, those days are gone forever, and the man who measures his output power in hundreds of watts may do well to consider the advantages of a screen-grid amplifier tube

such as the UV-861. This tube has come at an opportune time—while we are house-cleaning and planning new transmitters it is well to consider the advantage of screen-grid tubes.

DESCRIPTION

The tube is a product of the never-ceasing development work of the Research Laboratories of the General Electric Company and is marketed by the Radio Corporation of America. Its output rating is of 500

watts (yes, $\frac{1}{2}$ kw.) and the allowable plate dissipation is 400 watts. The tube construction is not unlike that of the UX-860 although the comparison should not be taken too seriously. The 861, for instance, stands eighteen inches high and has a wing spread of about thirteen inches, thus taking up quite a bit more space than the 204-A. In fact, it is one of the largest glass air-cooled tubes constructed for general operation.

In addition to the three arms such as are found on the 860, the 861 is equipped with a smaller fourth arm opposite the horizontal one that supports the plate. It is used as an ad-

ditional plate support. The control-grid lead is brought out through the top arm and terminates in a special base that fits nicely into the plate mounting of a 204-A. The plate lead is brought out through the larger of the two horizontal arms and is of

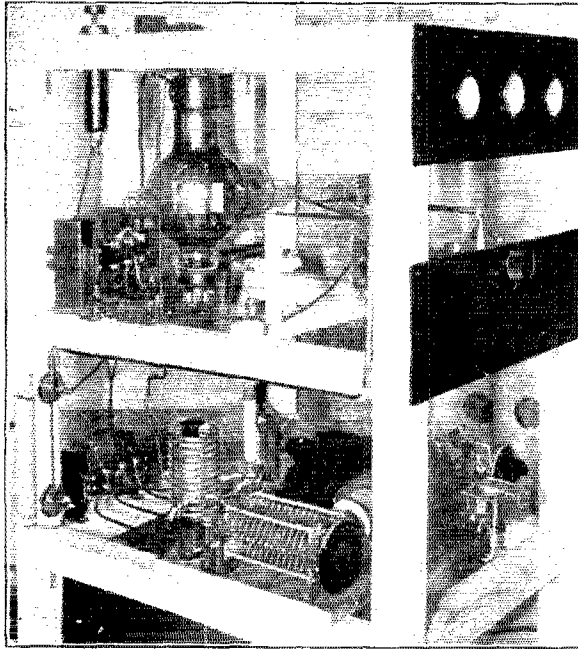

THE 500-WATT CRYSTAL CONTROLLED TRANSMITTER
AT WISZ

The framework is two feet square and four feet high and is constructed of 2" by 2" soft wood. In the lower section at the right can be seen the crystal oscillator and frequency doubling stage. In the center of the lower section appears the tank circuit of the last frequency doubling stage employing a UV-211 which can be seen by the side of the r.f. choke. The transformer at the left supplies the filament of the 211. The 861 and its associate equipment is located on the upper shelf. The tube is mounted with the control-grid at the bottom allowing a direct lead to the 211 stage. The transformer at the left supplies the filament of the 861, its output voltage being controlled by means of the Bradleysat at the top of the framework. An R.E.L. 100 upfd. high voltage variable condenser tunes this tank circuit. The three Weston milliammeters on the panel are from left to right in the plate circuits of the 211, 861 and two 210's.

*WISZ, Editorial Dept., QST.

double-stranded wire. Both strands should be used to reduce uneven heating and resistance losses which may become important at high frequencies. At the base of the tube are brought out the screen-grid and filament leads. The familiar grid-filament mounting for the 204-A fits into the picture here, also.

OPERATION

The tube is designed for power amplifier use at high frequencies. According to theory, it should be possible to operate it at the same frequency as the oscillator or preceding stage *without* the need of neutralization—that comparatively simple process whereby a tube may be made to act as it should but which said simple process seems to be a great mental hazard, if nothing else, to the amateur in general. As above, the tube should not need to be neutralized—and in practice it doesn't. Now are we all happy? The fellow with the large oscillator tube may now use an 861 to advantage and should said person be of the type who detests tackling the art of neutralization he needn't tangle this bit of black magic.

AN 861 SET-UP

The transmitter at W1SZ in which the 861 is employed is controlled by a crystal in the 3,500-kc. band. The crystal tube is a 210 which obtains its plate voltage from a small Acme transformer. A Raytheon BH tube acts as the rectifier and although the 400-volt output is more than the tube is rated to handle it has given no trouble. This supply also handles the first frequency doubler, a 210, the output of which is in the 7,000-kc. band. There being but one milliammeter available, it serves for both the 210's. Grid bias for the oscillator is about 45 volts and for the first frequency doubler is 250 volts. The second frequency doubler which puts us in the 14,000-kc. band is a UV-211. Its plate voltage is realized from the main supply to the 861 through a 10,000-ohm resistor. The optimum bias for the 211 will be less than that needed for the 210 doubler and in this case 125 volts were plenty. The bias is obtained from Burgess "B" batteries. The 861 stage operates on the same frequency as does the 211. The control-grid bias is obtained from a separate battery. This is not absolutely necessary but an extra battery was available and we were not placing too much faith in our r.f. chokes. The bias voltage doesn't seem to be critical so treat yourself to a small 45-volt battery and be on the safe side. There being no current drain from this battery, its life is long. In operation little difference was noted between 22.5 and 45 volts.

TUNING UP

The next hardest step is the tuning up process though one usually looks forward to this. It might be well to start with the subject of r.f. chokes, a point which should not be overlooked if one wants to be saved both time and grief later on in the proceedings. R.f. chokes with some choking ef-

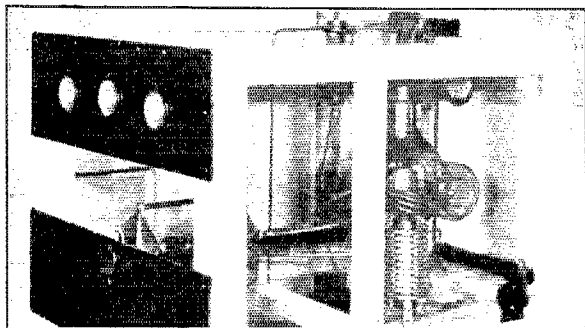

A CLOSE-UP OF THE 861 STAGE TAKEN FROM A DIFFERENT ANGLE

This photo shows the method of coupling the antenna to the amplifier inductance. At the right of the inductance may be seen the resistors for the screen-grid voltage. An idea of the size of 861 may be had when it is seen that it takes up nearly the two feet of height in the amplifier stage.

fect are needed in all negative bias leads. Use chokes to which you have been accustomed in the past providing you have not found them to be faulty before this. It might be well to start off with the oscillator and test each stage with a neon tube. Should there be any glow at the battery end of the choke it should be ripped out and a choke substituted that will stand up under the neon tube test. When you are reasonably sure that the chokes in the crystal stage are suitable, it is time to proceed to the first frequency doubler.

When the tank circuit of the 210 doubler is tuned to twice the crystal frequency there will be a drop in plate current that will be indicated on the milliammeter which is in the common supply lead to the two 210 tubes. With the tank circuit adjusted for the greatest plate current dip, go back to the oscillator stage and run the condenser up toward maximum until the crystal tube stops oscillating. After noting where the point is at which oscillations stop, swing the condenser back to zero and proceed upward again, this time coming nearly to the point at which oscillations cease and be satisfied that you have maximum output from those two tube circuits. When these two condensers are finally adjusted they need never be touched again unless the r.f. coupling lead between the stages is shifted.

Now, try the neon tube on the chokes in the doubling stage and when the chokes

show no r.f. at the low end, we will take it for granted that there is no r.f. feed back through a bum choke. If this surmise is correct, all will be well; when the crystal stops oscillating the milliammeter will drop and by turning the condenser of

choke back all unwanted r.f. Should there be much r.f. getting back into the preceding stages you may easily wreck that fragile little slab of silica known as a crystal.

When the 211 stage was first operated,

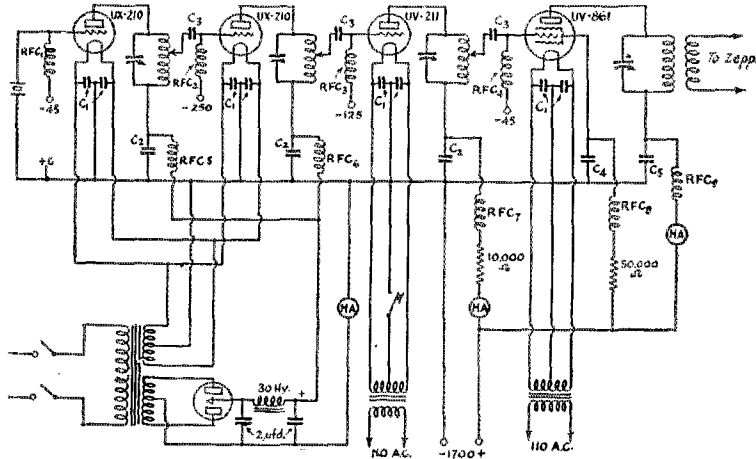

FIGURE 1. THE SCHEMATIC WIRING DIAGRAM IS SHOWN HEREWITH.

The plate supply for the last two stages is obtained from a motor-generator set. C_4 should be of large capacity. Preferably a 1- μ d. filter condenser if you can spare one.

C_1 have a capacity of .006 μ fd.

C_2 are .02 μ fd.

C_3 are .003 μ fd.

The r.f. chokes are all on 1" test tubes. The chokes above 7000 kc. were made of about 350 turns of No. 34 enamelled wire. The chokes in the 7000 kc. portion of the transmitter were the same with the exception that only 250 turns were used on the test tubes. On 14,000 kc. 300 turns were found about correct.

Keying is shown in the filament of the UV-211. Another place that is easy to key is between the r.f. choke and the negative bias for the control grid of the UV-861.

the amplifier stage nothing will happen, the circuit will not start to oscillate of its own accord.

The next step is to light the filament of the 211 and apply the plate voltage, the bias being already on, of course. We aren't going to worry about keying yet so use the switch in the plate voltage supply line to turn the power off and on. Tune the output tank of this stage to twice the frequency of the preceding 210 at which point, the milliammeter in the plate lead will take a dive up to about 100 mils. Now, stop the crystal from oscillating. The milliammeter in the 211 stage doesn't drop at all! She must be oscillating. By listening on the monitor you will soon have your suspicions verified. Try the neon tube on the choke. It will probably be ablaze through the entirety of the choke. Fine—all you have to do now is wind chokes for the rest of the evening with your thoughts on what you are doing and far away from DX. Do not turn the crystal stage on again until this choke in the bias lead has been made to

the Raytheon rectifier tube glowed brightly because the choke was no good and plenty of r.f. was getting back into the power supply of the crystal and first doubler tubes. From this it can be seen that it is not without justification that the point of needing effective r.f. chokes is stressed. When things are as they should be, with the crystal oscillator stopped or the first frequency doubler detuned, there is no plate current for the 211. With the crystal oscillating and the doublers working, there will be about 100 mils representing about 100 watts input to the 211. This is more than sufficient to swing the grid of the 861 when it is considered that the input to this power stage is but 350 watts. It should be sufficient to control inputs up to at least a kilowatt and what amateur needs half that?

The next step is to get the 861 controlled by the 211 output. Heretofore when frequency doubling we have had no trouble getting the various stages to mote as they

should but now we are tackling something of a different nature. In the past we have sweat, tuned and cracked crystals by running up the output of the crystal stage in order to control a 204-A in the 14,000-ke. band. We have never had much luck and always went back to the self-excited circuits. Perhaps, we can get this amplifier stage working without getting discouraged and following precedents set before.

With about 45 volts on the control grid, we turn on the plate voltage to the 861 which automatically applies voltage to the screen-grid, that element being supplied from the plate source through a resistance of about 50,000 ohms. The tank condenser of the 861 is run through its range and if the amplifier doesn't start operating, either the 861 is not getting enough excitation or the 211 stage has been detuned by attaching the grid clip to feed the 861 stage. To correct the first fault, move the grid clip up nearer the plate end of the 211 stage tank coil. Very little coupling was needed in this case, two turns being ample. The tank of the 211 is then retuned, this time noting any little increase in plate current to the 861. At the point where the plate milliammeter shows a slight increase, the 211 stage is in step and the 861 tank circuit should be adjusted until maximum plate current is obtained. By detuning the previous stages or abruptly stopping the crystal from oscillating, one can check whether or not the 861 stage is oscillating of its own accord. This may not be the final check, so detune the 861 tank circuit and see if it is possible to get any output on other frequencies that are not regular harmonics. If no response is had, you may be sure that the output is crystal controlled and by checking this with the monitor you will find a steady d.c. shrill note with no change in frequency when the condensers are detuned, merely a change in audibility.

Let's see what happens if we try to put in a neutralizing condenser. True, the final stage is not oscillating at present but we have visions of the past in which nice oscillating crystals were taken out of the holder—chips. Looking around, we find a double-spaced condenser capable of standing the high voltage which will be impressed across its terminals in this case. The stator of the condenser is connected a few turns below the low end of the plate coil and the rotor goes to the control grid. By adjusting this condenser, the input to the tube may be varied although it is not as critical as we thought it would be.

Let's couple the antenna and see what effect it has upon the output. With the antenna coupled and no neutralization, we note the input to the 861. Now we note the maximum antenna current and insert the neutralizing condenser. With some ad-

justments, the antenna current can be made to increase considerably. Fine! Obviously, this isn't due to a more perfect balance but is caused by increased regeneration in the amplifier stage. However, inasmuch as the circuit shows no tendency toward self oscillation we might just as well take advantage of the fact and use this extra output. We aren't worrying about crepage, over heating of tubes, et cetera; all we want is maximum output in that little sky-

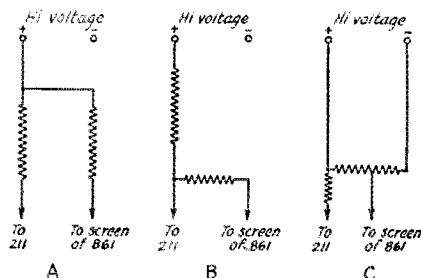

FIGURE 2. THREE METHODS OF OBTAINING VOLTAGE FOR THE SCREEN-GRID ARE SHOWN ABOVE

A is the arrangement employed, the screen being connected to the plate supply through a resistor. A separate resistor drops the voltage to the plate of the 211 stage. At B, advantage is taken of the drop across the resistor in the plate lead of the 211. This is not so good in that it offers a coupling between the two stages and the voltage on the screen will vary when the current through the plate circuit of the 211 changes. At C we have a simple potentiometer method which is most suitable but requires more resistance than the other two arrangements.

wire at the one frequency set by the crystal and we don't care how we get it.

Suppose we get critical now. By listening closely on the monitor we realize a very nice signal although it is not d.c. Let's put some filter on the generator. With 2 mikes on the output of it there is no discernible improvement. Wait, this generator is just feeding the amplifier tubes which are controlled by the crystal oscillator. No matter how pure the amplifier supply may be, it will have little or no effect if the oscillator supply is not as good. Well, we don't mind that a bit because the oscillator supply does not call for high voltage equipment so the original 2 mikes in the oscillator plate supply was expanded to a brute force affair of 2 mikes, thirty henries and 2 mikes. A listen on the monitor indicates that the note from the crystal is more like it should be, as pure d.c. as one would want. With the amplifiers in operation, the signal is louder but that's all. No change in note is noticed.

Considering the cost of a crystal controlled set, it would seem that one big item in its favor to stack up against the "out of the question" expenses involved is the fact

that a comparatively rough amplifier plate supply will be practically as suitable as one that is adequately filtered. Anyone who has tried to filter 2,500 volts knows that it takes a large outlay of cash to accommodate this item. And now that Christmas and New Year's day is past with the bills coming through in every mail this fact can be brought home stronger than ever. Therefore it can be seen that putting in crystal control on a high powered outfit would offset the filter expense—and what a fine signal you will have for this first year in our new channels. We don't want rock crushers any more. Signals that cover 5 and 10 kc. are absolutely taboo now. Why not have all that power concentrated on one frequency and make it stay there!

KEYING

This subject has been left to the last because it was not needed up forward in this script. In the past it seems that many with crystals have keyed so that there would be a back-wave on the air at all times. They seem to think it necessary to impress upon others the fact that they have crystals as if we couldn't tell by listening to them. They may be keying in the bias lead under conditions that do not drop the plate current to zero when the key is open. They may be keying in the antenna and due to the capacity between the key contacts, the current does not fall to zero. Any method of keying which allows a signal to be emitted while the key is up shows a distinct lack of courtesy on the part of the operator. Give the man with a weaker signal the chance to bust through your racket. It seems to me to be nothing more than poor etiquette to continue to use such methods of keying. We are not living in the past. We must realize that every kilocycle is valuable. Why should a signal take any more space in the spectrum than is absolutely necessary to carry on the correspondence at hand. With these arguments in the back of our head we resolved that we were not going to be an air hog.

A separate filament heating transformer was installed for the 211 stage and the key was located in the center tap lead. While this does not allow the load to be kept on the tube at all times and the heating and cooling of the tube will change its capacity, the crystal will take care of these changes. That's why it's being used! No key clicks have been noted so far and there is no lag in the keying. We can go ahead just as we used to when we were handling traffic with Himoe at WNP last year and he would tell us to "speed her up" when we would get tired of wagging the bug back and forth at the speed he wanted to copy. Back wave—there is none. There can't be. The whole 14,000-kc. equipment is dead until we punch the key. And that's as it should be.

CONCLUSION

This lay-out is not described because we think it a station with great merits. We don't believe it has any. The set itself in appearance is not the type of mechanical work we wish we had done. The 861 was acquired to see if it would work as we had hoped it would. We, therefore, hooked it up in an experimental layout to see what the results would be. We have seen and wish now that we had taken the pains to do the tube justice.

The capacity of the wiring in all stages should be kept at a minimum. This is especially necessary if no shielding and neutralization is contemplated and applies particularly to the last two stages. Should feedback start here and get back through r.f. chokes the poor crystal would have to buck a considerable amount of power and fail in the attempt.

Let it be said here that one cannot take too much precaution in the crystal stage. Should this link be weak your chain will never break—it will never even get into action. It is well worth the expense to get a real power crystal that will stand 450 to 500 volts. A crystal with one frequency quite close to another will slide back and forth and had best be used as a souvenir rather than an oscillating blank. A crystal that will not step right up when the power is applied should be washed and put in a weather and dust proof mounting. If it still fails to mote at every crack, the bias on the crystal tube should be lowered and if it still persists in being backward about starting to oscillate, it should join the ranks of the first example of "what-not-to-be for crystals". You will derive little enjoyment from a crystal set if you are always poking at the crystal to get it started. The crystal should be put in the holder and forgotten for some months to come. Only in this way can maximum enjoyment be derived from crystal control and let me say that real enjoyment is obtained from it. Always the same character of signal, always on the same frequency and always ready to go.

Reports on W1SZ have been very gratifying but no more than we expect. We can tell by listening to the monitor that the emissions are of a "1929" quality and no mistake. We aren't going to operate the set only in the 14,000-kc. band either. When we want to operate on 7,000-kc. we will cut out the 210 frequency doubler and tune the 211 stage to 7,000 kc. Then the 861 will be run down to the lower frequency. For 3,500-kc. operation, the 211 stage will be neutralized and operated at the crystal frequency and follow with the 861 also at the same frequency.

A Multi-Range Voltmeter

By Harold P. Westman, Technical Editor

BECAUSE meters are expensive as seen from a dollars and cents point of view, it seems silly to spend a given amount of money for several meters in order to cover those ranges that are necessary in the general run of amateur work. How much better it would be to get one meter and make it do the work of a whole family providing, of course, that no serious losses are entailed either in accuracy or convenience.

Take for example the problem of measuring d.c. voltage. There are about three ranges of voltmeters that would be needed around the average station. First there is the matter of checking filament voltages on all sorts of receiving tubes. This requires a meter having a range not exceeding ten or fifteen volts or the lower readings will be inaccurate. Next we have "B" batteries to test and a range of at least fifty volts is necessary here. We then have the higher ranges of voltages used on the plates of transmitting tubes. In addition to these, it is a rare amateur who is not at least occasionally called upon to check over the neighbor's broadcast receiver. For this job, a high resistance voltmeter going to at least two hundred volts is necessary to measure the output of the "B" battery substitute usually installed. Needless to say, the three or four instruments necessary to take care of these common direct current voltage measurements are collectively quite expensive and for work of this type not requiring very great accuracy, it is possible to come out somewhat ahead of the game by making up a multi-range voltmeter that will be capable of doing all these jobs and some in addition.

Fortunately, it is possible to purchase low range milliammeters at a price within reason. Resistance units that are suitable for use as multipliers may also be obtained without the necessity of robbing a bank. Thus we have the "works" for a voltmeter and all that remains is to put two and two together and see that the result is four.

The instrument shown in the accompanying photo has six ranges as a voltmeter in addition to its regular range as a milliammeter. It consists primarily of a Weston 0-1.5 milliammeter and eight resistors that comprise the multiplier. If we desire a range of 1.5 volts, Ohm's Law prescribes a resistance of 1,000 ohms to give 1.5 milliamperes through the meter at that voltage. The resistance of the meter is comparatively low and can be neglected. The inaccuracy due to the meter resistance will be greatest

when the lowest value of multiplier is used. This is at the low voltage range where a check can most easily be obtained. We also see that the meter, giving a full scale deflection with but 1.5 milliamperes, is suitable for measuring the output of "B" battery substitutes because the insignificant current drain will not affect the operation of such a device.

The six ranges provided give full scale deflections of 1.5, 15, 150, 300, 750 and 1,500

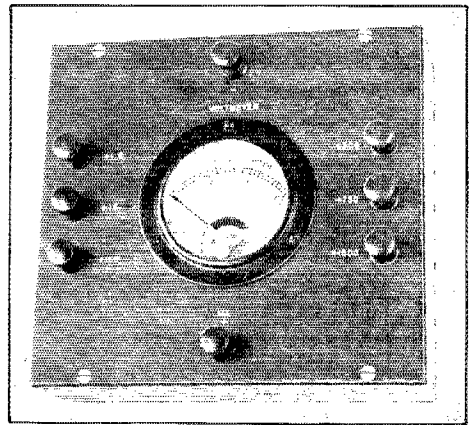

THE GENERAL APPEARANCE OF THE METER MAY BE SEEN ABOVE. No cover is provided, it being considered unnecessary. Although if the unit is to be used for the servicing of broadcast receivers or other work requiring good portability, it would be very desirable that one be made. Small rubber feet are attached to the bottom to prevent scratching of both the meter and table top and a small leather handle is fastened to the top side.

volts and a binding post is included which allows the milliammeter, as such, to be used. These ranges give satisfactory overlap when going from one to another and cover practically all the values of voltage that are normally found in the ordinary station. It is very probable that higher voltages are being used by some amateurs and it is a simple matter to obtain different sizes of resistors and thus extend the range of the meter. It should be practical to cover well up towards 5,000 volts if that is desirable although in general the 1,500-volt range should be sufficient.

Super-Davohm resistor units manufactured by the Daven people are employed as the multipliers. These units are wire wound and resemble a grid leak that has had too much turkey for Christmas. While of

the standard grid leak length, they are materially thicker and have heavy brass ends which fit into standard grid leak mountings. They are obtainable in various sizes between five hundred ohms and five megohms and are guaranteed to be within

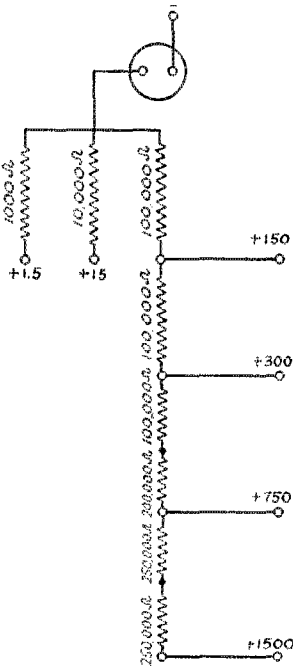
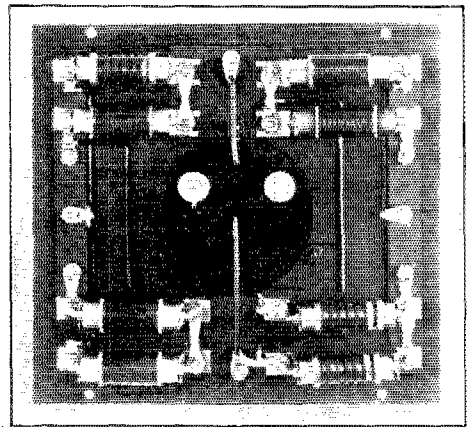

FIGURE 1

1% of their rated values. If we assume the resistor to be off by that amount and the meter to be inaccurate to 0.5%, the total inaccuracy will be approximately 1.5% which will not be damaging as far as the general run of amateur work is concerned. As a matter of fact, there is usually too much stress placed upon the accuracy of the meters used and too little upon the reading of them and the reasoning employed in the making of most measurements. Folks that brag about the meters they have that are good to the 'steenth place, oftentimes have a mentality good to about one decimal place and sometimes not quite that. The result of most amateur measurement work depends not so much upon extreme precision in the actual measurement of the circuit values as it does upon the accuracy with which the values so obtained are handled by the worker. Outside of the measurement of filament voltage which has a large effect upon the life of a tube, there are precious few measurements the amateur makes that require an accuracy greater than 2%.

To get back to our meter. Figure 1 shows the value and position of each resistor employed. Two 250,000-ohm units are required for the last step in order to handle the full-scale current of the meter and still allow sufficient safety against burn out. The resistors are capable of dissipating 1 watt and the maximum current that should be passed through the 250,000-ohm units will be 2 mils. This allows an overload of approximately 30% which should be sufficient for most work. A 500,000-ohm unit (the next larger size) would be capable of passing only 1.41 mils and would be unsuitable. In Figure 2, appears a simple plan view of the layout of the units. It is a back-of-panel view and as can be seen, the majority of connections can be made by overlapping lugs, there being comparatively few wires necessary. This is shown in the interior view. The list of parts needed is given below and while the total cost may seem appreciable at first, when compared with the cost of a 1,500-volt meter that has but a



THIS VIEW SHOWS THE SIMPLICITY OF WIRING. The majority of the connections is made by overlapping the lugs used. The wire need only be heavy enough to insure mechanical rigidity as its resistance is insignificant. The insulation should be good as the difference in potential is several hundred volts and may be impressed across portions of the circuit. Some of the paper labels have been removed from the units to show their construction. If high humidity is encountered, it might be good to remove the paper which may act as a parallel resistance path to the winding. This applies particularly to the very high values of resistance that would be used in meters giving full scale deflections for three or four thousand volts.

single range and is not suitable for measurements of low voltages, it is really quite reasonable.

1 0-1.5 milliammeter	\$12.00
1 panel 7" by 6.5" by 3/16" Bakelite	.75
Engraving on panel	2.75

(Continued on Page 51)

Experimenters' Section

IN OUR December report, there was presented to all a problem concerning the recording of clock beats and in particular the need for some satisfactory method of indicating the start of each minute upon the chronogram. Apparently, there was considerable interest generated upon the part of the Experimenter and we are presenting some of the solutions suggested.

7 Kirkland Street,
Cambridge, Mass.

Editor, *QST*:

Mr. D. F. Brocchi has described in the "Experimenters' Section Report" (page 46) of the December, *QST* a method of operating a chronograph from a clock. He has succeeded in recording the seconds but wants suggestions for satisfactorily recording the minutes. I offer a scheme which has occurred to me and which, I think, could be easily carried out.

Instead of taking the once-a-minute impulse from the clock itself, it can be taken from a separate instrument controlled by the relay. All that is necessary is an anchor escapement with a suitable wheel and an electrically driven rocker. Figure 1 shows the general idea although details have not been developed.

The device may be mounted upon a wall in which case the wheel can be driven by a weight; or, if a portable appliance is wanted, a spring drive must be used. I assume that Mr. Brocchi's relay acts once a second but that is not important. However, every time the relay acts the escapement wheel will turn one notch. A wheel of suitable size (probably 60 teeth) can be chosen to make one revolution per minute. A contact arm can be attached either to the wheel or to its shaft and the once-a-minute interruption effected in any way desired. The magnet coil can be connected in series or in parallel with the chronograph or it may be connected to a separate relay. Care must be taken that the interruption of the chronograph does not affect the escapement.

A dial may be made to show the position of the contact arm so that any failure of the escapement could be detected by comparison with the second hand of the clock.

I hope this suggestion may be of use.

—*Laurence Bachelder, W1AWU.*

1511 Poplar Street,
Terre Haute, Ind.

Editor, *QST*:

Referring to the request in the December issue for some method of making a minute marker for a chronograph, I wish to submit

the following idea. The method herewith suggested may be given a trial if all the conditions are acceptable to Mr. D. F. Brocchi, who, according to his description of the work already done on the clock is, no doubt, a very skilled artisan and will appreciate the fine points involved.

Assuming that the clock has a deadbeat or Graham escapement and beats seconds, the scape wheel makes one revolution every minute.

Drill a very small hole in the rim of the scape wheel and drive in a small pin such as the hardened and polished end of a small sized cambric needle leaving about 1/8 to 3/16 inch projecting on one side of the wheel.

Then mount on a thin slab of bakelite two small contact springs as follows. The springs should be of 14-karat yellow gold on account of the almost frictionless slip this

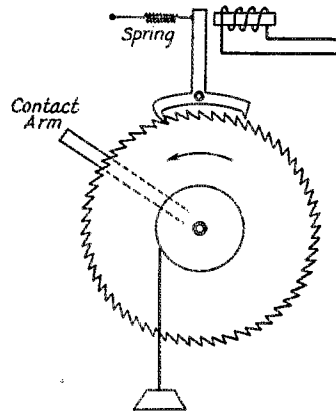

FIGURE 1

metal presents to steel, and the contact points should be tipped with platinum, or the springs may be made of 10% iridium platinum.

The springs proper should be about 0.001 inch thick by 0.01 in. wide and from 3/4 to 1 inch long. They should be soldered to heavier base pieces which are screwed to the bakelite slab so that the springs project beyond one end of the bakelite to their full length, one being on top and the other on the bottom. Bend the end of the top spring down at right angles and provide a stop to arrest its downward motion at a certain point. Then make a V bend in the under or wiper spring and let the end extend a safe distance beyond the V

(Continued on Page 78)



Conducted by A. L. Budlong

National Sections of I. A. R. U.

FOR the information of readers everywhere, we are listing herewith the existing national sections of the Union, together with other pertinent information. The Union is now an organization of the foremost national amateur societies; it is the aim of the officers eventually to include on the membership list the representative amateur organizations of every country in the world where there are transmitting amateurs.

There are now in existence fourteen national sections. All of them were created prior to the adoption of the new Constitution. It will be noted that in all but three cases (Argentina, Brazil and Switzerland) the foremost national amateur organization

application to Union headquarters before any society can be recognized as the national section for its particular country. Societies not included in the following list are not members of the Union; the secretary will, however, be glad to receive applications from amateur societies in countries where sections do not yet exist.

At the present time, negotiations are under way for recognition of national societies in Norway, New Zealand, Poland, Czechoslovakia, Portugal and Denmark.

ARGENTINA

The Argentine Section was formed on March 11, 1926. No national society has yet been recognized as the national section, however. The President of the Section is

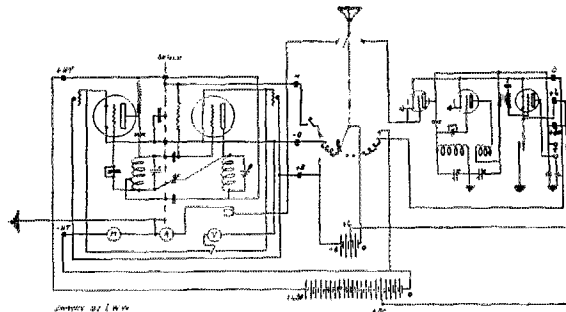

TRANSMITTER AND RECEIVER CIRCUIT OF
4MBWK

has been recognized as the national section. In a recent visit to headquarters, Mr. Abreu, president of the Brazilian Section, expressed his desire to take the same step in Brazil immediately on his return to his own country.

It has been noted that some societies in various countries, while not actually members of the Union, are so stating on their letterheads. We must point out that in all cases it is necessary to formally make

Mr. Enrique L. Repetto, Santa Fe 1592, 60 Piso D. 12, Buenos Aires.

AUSTRALIA

The Australian Section was created on August 6, 1927, and on January 24, 1928, the Wireless Institute of Australia was recognized as the National Section. Correspondence should be addressed to the Hon. Fed. Sec'y, Mr. Bruce Hardie, 22 Missouri Ave., Garden Vale, Melbourne.

(Continued on Page 60)

Calls Heard



W. R. Jardine, 264 Buckley St., Essendon, W5 Victoria, Australia.

wlwf w2com w2cxl w2xaf w2xad w4rn w4tk w5ael w5bj w5pa w5ql w6aqj w6am w6avj w6chk w6cwm w6dkv w6dny w6hal w6hnl w6cam w6dgp w6chs w6com w6dgv w6ef w6ej w6eln w6ln od-1jr oo-1lp op-1cm op-9pb op-1pw op-1hr oh-6avl oh-6ah oh-6eck se-1ea nz-ez5 nz-nba am-ane oz-1ac oz-1an oz-1ap oz-ax oz-1fb oz-1fm oz-1fw oz-2ab oz-2at oz-2aw oz-2ax oz-2aj oz-2be oz-2bg oz-2bf oz-2bv oz-2go oz-2go oz-3ar oz-3at oz-3av oz-3aw oz-3az oz-3cd oz-3cr oz-4ae oz-4av oz-4ao jkzb.

SS Westerner, WBCS, J. S. Morgan, Jr., Operator.

wlaaw wibal w1ba w1bgm w1bob w1cfl w1cmp w1cow w1era w1che w1jr w1kk w1kn w1mk w1rd w1wv w2aau w2acd w2afa w2aft w2aib w2beh w2bhr w2bhv w2boz w2fp w2ja w2jd w2md w2vi w3acu w3afx w3ahp w3avl w3bnu w3cnd w3ckl w3gt w3ia w3mt w3uo w3zce w3adh w3afe w3afe w3ale w3es w3ev w3gw w3pf w4ft w4tk w4al w5afx w5ain w5yr w6aak w6bam w6bax w6bws w6cho w6cjl w6czk w6dli w6no w6vz w7ek w8ads w8ath w8bau w8baz w8bcu w8che w8cut w8dri w8dyi w8dyz w8kr w8uk w8xe w8yap w8cos w8erd w8eck w8eck w9fax w9fi w9gdh ve1br ve2ca ve3ay ve3bc ve3ia ve4gi et-1bl et-1cn et-3am eb-4cn eb-4fe eb-4re eb-4uo eu-lug ed-7ah ee-ear37 ee-ear53 ee-earn ef-8br ef-8est ef-8gd ef-8je ef-8rk ef-8rrm ei-1fu ei-7dd ek-4ar ek-4dkf ken-ja et-tpar g2ao g5by g5wq g6br g6vy g6yj g6zj klaf awsw wnbtt.

C. R. Plant, 1 Albert Rd., Northenden, Manchester, England.

w5mx w6ad w6aee w6bco w6bx w6bvx w6cmd w6cjp w6dto w6cco w6cni w6hm w6ji w6kd w7aik w7if w7tu op-1ad op-1cm op-1cy op-1hm op-1hr op-1pw ac-1ax ac-1aw ac-8zw od-5az ad-4lra as-1ap as-2ber as-rao3 w5afx w6aqz w6afx w6bec w6bx w6cjp w6cni w6dhs w6dva w6dy w6de w6czk ac-1pp ac-1wl ac-1tb ac-2ab ac-2mo ac-2tn op-1ah op-1rz ai-jpb ai-7cb aj-4ef oa-2og oa-3lp oa-4cg oa-4mf oz-lax as-1ae as-1ak eu-2ev eu-4af ef-8gj au-8aa xnu-4eff.

W8DED, Russell Sakkers, 53 East 7th St., Holland, Michigan. (3500-3550 Kc. fones)

w1akd w1ayl w1ayo w1cks w1bjq w1cz w1st w2aow w2ahl w2ahm w2ata w2bee w2el w2rj w2t w2w w3aeq w3ain w3akw w3bqp w3bsz w3bup w3cah w3cc w3cjr w3oo w3qy w3sl w3sn w4ath w5axl w8abu w8aci w8afh w8aef w8aei w8ahf w8ajh w8ako w8aky w8ano w8aif w8aub w8ayu w8avq w8ayl w8bas w8bhn w8bhf w8bhd w8bot w8buw w8ccz w8cfy w8cgo w8ckd w8cj w8cqi w8cwe w8cwu w8dnd w8dsv w8dt w8dus w8dyf w8dva w8dvw w8dwm w8dxq w8t w8rd w8rw w8rk w8zq w8afv w8agq w8aho w8ahk w8agy w9ala w9ayl w9cm w9cu w9ch w9bka w9bwi w9bzq w9ech w9che w9emt w9eym w9czq w9ek w9vl w9fz w9so w9mm w9mq w9qd ve3et.

XEN-OQQ, S. S. Helder, Heard of West African Coast

On 20 meters

wlaep wlang wlaqt w1bjd w1bf w1cfl w1cje w1era w1fs w1mx w1ry w1sz w1zz w2aan w2aog w2api

w2atk w2arb w2avq w2azu w2baa w2bcw w2bds w2bjz w2bjs w2bjv w2boa w2box w2bps w2brb w2ch w2cix w2euz w2dr w2fp w2jn w2lx w2mb w2md w2ra w3amw w3aqm w3bjm w3jm w3ky w4rn w4ft w5avs w5nb w5om w5wz w5yd w6esw w6czk w6dev w6zdd w7tu w8abw w8ady w8afq w8ann w8aur w8bcu w8cbd w8cel w8dyk w8hx w8jj w9aji w9aim w9cfm w9enr w9oqk w9ted w9yfp velap ve2ap ve3es ve3bm ve4fv sa-fcb sb-1cm su-2ak fo-a7d fo-rin w3m.

30-40 meters

w1awm w1cmp w1ic w1mx w2atr w2ja w2jdw w4tk w4vp w5ux w6awa w8abw w8aff w8ajy w8baz w8adg w8bcu w8brh w8bqe sa-en8 sa-je7 sb-1bl sb-1bs sb-1cm sb-1ls sb-2ak sb-7ab sc-2ab ef-8br ef-8cdd ef-8jf ef-8kf eb-4wk eb-4ft xeb-4wk eu-2ai nj-2pa fl-1ab fo-a7u fg-ocdl fg-ocya fg-pm.

Basil Hall, 25, Coombe Gardens, New Malden, Surrey, England.

30-50 meters

w1aao w1aqt w1che w1cmp w2au w2arq w2atq w2azk w2bgo w2com w2cqr w2jd w2jdw w3afv w3awb w3avl w3bce w3ckl w3qe w3z w3uo w4es w4rn w5ic w5adg w8ann w8au w8dm w8u w8yq w8xe w9arn w9beh w9bh w9cv w9em w9en w9p w9dz w9ez w9es w9ejo w9fk w9ln w9us et-1au et-1bv et-1ca et-1ef et-1cn et-1et ea-fay ea-fay ea-hz ea-lr ea-lrk ea-lrs ea-pp ea-r28 ea-ra ea-w5 ea-wg ea-4lr ee-1ema ee-1na ee-2lo ee-2rm ed-7ah ed-7er ed-7ln ed-7re ee-earl6 ei-1as ei-1dr ei-1po ei-1alk ei-1a2b ei-1a2z ei-1a5m em-smua em-smux em-smve em-smxh em-smzf em-smzy ef-5af es-1co es-2nae es-2nap es-2nm es-2nx es-5ng es-5nk es-5nl es-7nb et-pzz et-tpar et-tpa et-tpfm et-tpmn et-tppt et-2as eu-e8pm eu-nno eu-2aee eu-2ai eu-2bb eu-2bu eu-2df eu-2dw eu-5ae eu-5az eu-43ra eu-25rb eu-85rb ew-ae ew-an ew-au ew-hj ew-fv em-ph ew-ho ew-ox fe-egck fm-8cv fm-8rit ha-mfv oa-2ek oa-2jc oa-2jy oa-2rb oa-2yj oa-3hl oa-8jk oa-7ah oz-2go oz-3ar sb-2ak sb-2bc se-2ab velbx ve2ca.

14-27 meters

w1ack w1alb w1alg w1aqt w1aze w1btt w1bby w1bfz w1bil w1bv w1bpd w1cfl w1cje w1cmf w1fb w1kq w1mx w1ry w1sq w1sz w2aef w2ag w2api w2arb w2avq w2avz w2azl w2azu w2beq w2bgq w2bkf w2bmk w2bum w2bw w2ch w2cix w2evj w2fp w2hna w2hq w2jn w2md w2rs w2tso w3aqr w3eq w3ga w3ia w4ft w4nh w8aac w8aav w8adg w8agy w8al w8arx w8avs w8axa w8ccw w8eds w8ep w8ew w8cx w8x w9as et-1ef et-1cu ea-1r ea-4sn ee-1rf ed-7hp ed-7va ei-1gc em-smux es-2nt es-5nl et-1pkx eu-2bv ew-sn fk-4ms fm-8rit fm-8vx fo-a3a fo-a40 fo-a5l fo-a7d velap velar ve2ac ve2al ve2bb ve2bg ve2ca ve2jj.

EC-RP18, Henry Rakosnik, Sedlecpod Kankcn.

ec-1rf ec-1ab ec-1na ec-aa2 ec-1ema ec-1vl ec-1uz ec-1rv ec-1mx ec-1fm ec-1kj ec-1mk ec-2lo ec-2et ec-2ny ec-2un ec-2vd ec-2pa ec-2rm ec-2cm ec-3sk ec-3us ec-3wa ec-4av ec-4go ed-7va ed-7vo ed-7ab ed-7lm ed-7bt ed-7hp ed-7er ed-7ek ed-7dm ed-7wh ei-7bb ed-7ah ed-7ln ed-7sh ed-7cg ed-7am ed-7om ee-ear62 ee-ear62 ee-ear61 ee-ear ee-ear18 ee-ear23 ee-ear98 ee-ear104 ee-eare26 ef-8klm ef-8flm ef-8ava ef-8bas ef-8ral ef-8mpg ef-8gkc ef-8lem ef-8ei ef-8tdq ef-8nox ef-8ta ef-8xzl ef-8io g6wy g6fa g6vl g6zr g6vl g6hk g6gu g6bz g6rm g2bm g2hu g2hq gw-16b gi-6w eh-9mq

(Continued on Page 74)

Correspondence

The Publishers of QST assume no responsibility for statements made herein by correspondents.



The New Regulations

Department of Commerce,
Radio Division,
Washington.
December 19, 1928.

My dear Mr. Warner:

The Division has your letter of the 11th instant requesting information relative to the institution of new amateur regulations on January 1, 1929.

The only change that is being made in the amateur regulations is that provision relating to the frequency bands that may be used by amateurs in accordance with the International Radio Convention of 1927. A supply of the regulations including the new frequency bands is now being printed and copies will be forwarded to you as soon as available.

The Division does not propose to recall the outstanding amateur station licenses. However, the holders of amateur station licenses issued prior to January 1, 1929, will be furnished a copy of the new regulations in order that they may have before them the requirements as to the frequencies upon which their station may be operated.

Respectfully,

—W. D. TERRELL,
Chief Radio Division

“Blind” Flying

Medford, Oregon.

Editor QST:

The following is a report on an experiment performed on the Pacific Coast. There, as yet, no radio beacons are available for planes flying the mail and express routes from San Francisco to Seattle, and occasional difficulties in navigation occur over the mountains during storms and fog.

The thought came to the writer that, as the planes followed a direct route very similar to the telephone toll lines, it might be possible to follow them in some manner. It developed that there was a “pilot channel” of 24.3 kc. in continuous operation and that amplifiers on the line were less than 200 miles apart insuring good strength to this channel. This “pilot channel” is a sine wave current of, in this

case, 24.3 kc. and harmonics are used to demodulate suppressed carrier telephone currents.

A T. R. F. set was built and pre-tuned to 24.3 kc. The detector was an autodyne and gave a note of about 1,000 cycles. It was found that on the ground the pilot channel could be picked up as evidenced by the 1,000 cycle note within a mile of the line on either side when using a small untuned aerial and no ground. The same results held true for plane operation and the presence of the plane within $\frac{3}{4}$ mile of the toll line in either direction could be detected.

The advantage of this arrangement seems to be that there is no spreading of the wave as noticed in radio beacons, the carrier or “pilot channel” is there free of charge, though the frequency may change for different routes, the frequency is far enough removed from that of power lines so that no interference is had, the frequency is far removed from the natural electrical disturbances set up by the ignition system of the plane, and no interference was had from high power commercials. In going over the mountains naturally the telephone toll lines also go over the top allowing the plane to still hear the signal with plenty of flying room beneath.

The disadvantage is that there is no way of telling whether you are to the right or left of the toll line except by changing course and listening for an increase or decrease in signal strength. North and south (the direction in which the line runs) cannot be differentiated. These suggestions are offered in the hope that their practical application may help in navigating planes when they must fly behind.

—L. Dow Inskeep, M. D

W2UO

Knoxville Amateur Radio Club,
Knoxville, Tenn.

Editor, QST:

It is indeed with pleasure that we note the outcome of your efforts to have the station of the Times, W2UO, removed from the amateur band it formerly occupied.

The Times, in common with a good many others, was never entitled to a position in our bands and the Radio Commission merely

THERMO-COUPLE TYPE INSTRUMENTS MODEL 425

INSTRUMENTS of this type, originated and developed by the Weston Company, are universally employed for measuring both high and low frequency currents. Their use has extended with the wide application of radio frequency into a great number of fields of experimental engineering and commercial activity. Incomparable in their refinements of mechanical and electrical design and unusually accurate and dependable in performance for such small instruments, the Weston Miniature Meters—Thermo-Couple types as well as A. C. and D. C. models—are everywhere accepted as the highest standards for radio testing service.

Thermo-Couple Types

Made as Thermo-Ammeters, Thermo-Milliammeters, and Thermo-Galvanometers or Current Squared Meters

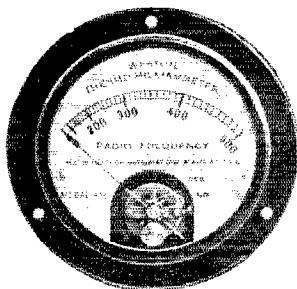

For Panel Mounting

Flush Type—2" and 3 1/4" diameter. Furnished in metal or bakelite cases. Portable mounting bases also supplied.

The Weston Thermo-Couple Type Ammeter is furnished in ranges from one to 20 amperes having a safe overload capacity of 50%. It solves perfectly the problem of measuring high frequency currents such as are imparted to the antennae. Equally accurate for low frequency measurements and gives satisfactory service for D. C. measurements as well as A. C.

Milliammeters are furnished in three sizes—125, 250 and 500 ma. They give definite assurance of the output and accurate readings after hours of constant service. Extra large overloads will not burn out these meters. They are ideal for short wave transmission as they have a very low internal electrostatic capacity. For this reason they give the true value of the current in the circuit and do not disturb the constants in a transmitter.

Write for Circular J.

WESTON ELECTRICAL INSTRUMENT CORPORATION
602 FRELINGHUYSEN AVENUE - NEWARK, N. J.

WESTON RADIO INSTRUMENTS

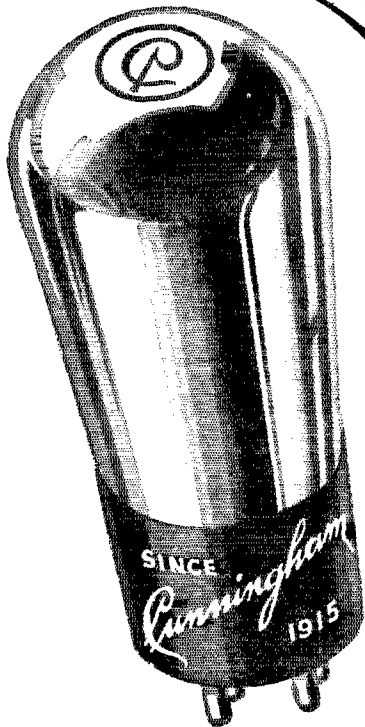

Since any radio, old or new, is only just as good as the tubes in its sockets, it is clear how vital a point perfectly balanced tubes are.

The brand of radio tube is just as important as the "make" of the set.

Insist on

Cunningham
RADIO TUBES

For Clear Reception

righted a wrong when their license was revoked.

Your position has been most proper and may your efforts continue until our meager bands are entirely clear of every station except the legitimate amateur.

Knoxville Amateur Radio Club.

J. B. Witt, Secy.

The Total-Loss Receiver

1287 Castle Hill Ave.,
Bronx, New York City.

Editor *QST*:

Colonel Foster knows something good when he hears it. The other amateurs not so close to your domicile, to be sure, know the good things when they see them. My vote of thanks to Mr. Ross A. Hull for the highly interesting and descriptive article in the November issue of *QST* on 1929 receivers—a most timely contribution to the art and a New Year's present to the hams.

W6HM says that aluminum for the panel is the bunk, admittedly its cutting and trimming is hard work. However, friend Ross must have polished the panel of the four tuber too high, because that's what caught my eye. So once again, the chips flew here and soon the four-tube masterpiece was realized. I was at once amazed by its wonderful performance. I found it to be in a class by itself as far as receivers go, for it successfully copes with New York City's air inferno, knocking Old Man Static and other parasitic noises into their rightful abodes and allowing the sounds most delightful to the ham to pour forth in abundance from all too small diaphragms.

However, a rude awakening from Paradise was the order and it took the few words suggested in the same article (relative to pressing the midjet tuning condensers into the jacks by using the fingers) to bring this about. It was shocking to me. One hundred volts plus on the condenser is quite ticklish. The stator is fed from the positive 135 volt side and the rotor is on the grounded negative side. Would not a pair of rubber gloves tested at about 3000 or 5000 volts be a desirable part of every operator's equipment? Why fool around with chances of permanent injury or death? You can get all the dead hams you want in Swift's.

The tuned impedance as I have it, is plug-in also. This is a departure from the plans laid out in Mr. Hull's article, for his inductance secondary of the Ford Coil is attached to the set's baseboard in semi-permanent fashion and is not easily accessible. A second stage audio frequency amplifying transformer is also mounted plug-in style and can be substituted very easily when phone reception is desired. In this way various tuned impedances and transformers could be arranged plug-in fashion and used to fit any necessary requirements.

Filling in the heads of countersunk screws with solder and sandpapering same flush with the aluminum panel gives the

Here's the answer to every question about the principles, methods, or apparatus, of radio transmitting and receiving--

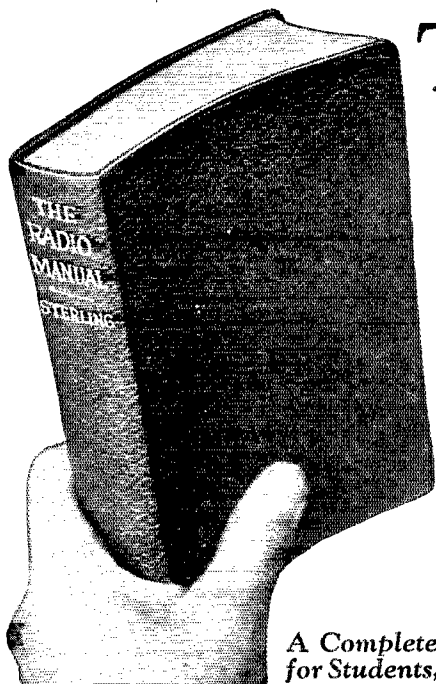

THE RADIO MANUAL

By G. E. STERLING, Radio Inspector and Examining Officer, Radio Division, U. S. Dept. of Commerce.

Edited by ROBERT S. KRUSE, for five years Technical Editor of QST.

The new procedure adopted by the International Radio Telegraphic Convention is effective January 1st, 1929. THE RADIO MANUAL records it completely. Department of Commerce examinations for operator licenses are changed the first of the year. Only THE RADIO MANUAL presents all the material to meet the requirements of the questions. Progress has been steadily made in perfecting radio theory and practise. THE RADIO MANUAL, since it is the most up-to-date volume on radio, is the surest source of complete and accurate information on all points.

A Complete Handbook of Principles, Methods, Apparatus for Students, Amateur and Commercial Operators, Inspectors

Complete Preparation for Government License. 16 Chapters Covering

- | | | |
|---|--|---|
| <ol style="list-style-type: none"> 1. Elementary Electricity and Magnetism 2. Motors and Generators 3. Storage Batteries and Charging Circuits 4. Theory and Application of the Vacuum Tube 5. Fundamental Circuits Employed in Vacuum Tube Transmitters 6. Modulating Systems Employed in Radio Broadcasting 7. Wavemeters, Piezo-Electric Oscillators, Wave Traps and Field Strength Measuring Apparatus 8. Marine Vacuum Tube Transmitters including detailed description of Model ET-3626 | <ol style="list-style-type: none"> 9. Radio Broadcasting Equipment including, for the first time in any text book, the complete equipment of Western Electric 5 Kilowatt broadcasting Transmitter used in over 75% of American broadcasting stations 10. Arc Transmitters including description of Federal Marine 2 Kilowatt Arc Transmitter Type AM 4151; also models "K" and "Q" 11. Spark Transmitters including description of Navy Standard 2 Kilowatt Transmitter 12. Commercial Radio Receivers and Associated Apparatus including, for first time in | <ol style="list-style-type: none"> any text book description and circuit diagram of Western Electric Superheterodyne Receiver Type 6004C 13. Marine and Aircraft Radio Beacons and Direction Finders 14. The Development of Amateur Short Wave Apparatus. Complete details of construction, operation and licenses 15. Radio Laws and Regulations of the U. S. and International Radio Telegraph Convention. Quotations of all important sections 16. Handling and Abstracting Traffic |
|---|--|---|

Examine It Free

Never before has so complete a treatment of radio theory and operation been compressed into a single volume. Here is information that otherwise you could secure only by consulting many different books. And every detail is vouched for by authorities of the first rank. The Manual is profusely illustrated with photographs and diagrams. There are 700 pages, bound in flexible fabrikoid that is extremely durable. The immediate demand for so valuable a handbook has already nearly exhausted the second large edition. To be sure of receiving your copy without delay, order at once. The volume will be sent for free examination. Pay or return in 10 days.

Order On This Coupon

D. VAN NOSTRAND CO. INC., 8 Warren St. N. Y.
Send me THE RADIO MANUAL for examination.
Within ten days after receipt I will either return the volume or send you \$5.00—The price in full.

Name
RAH 1929

St. and Number

City and State

Dubilier

TRANSMITTING

CONDENSERS



DUBILIER type 686 condensers have the usual Dubilier high safety factors for use in transmitter filter net works. 1000 volt DC rating.

May be connected in series where the working voltage exceeds 1000. Through series parallel connections practically any working voltage and capacity can be obtained.

DC voltage must not exceed 1000; or in A.C. supply filter circuits the transformer voltage must not exceed 750 volts per rectifier plate.

1 mfd. condenser \$5.00
2 " " \$8.00

Write Dept. 43
for free catalog

Dubilier

CONDENSER CORPORATION



10 E. 43rd St.
New York City

panel a wonderful appearance. I did not use the shock absorbing, non-microphonic sockets on the r. f. tube or tuning coil. The sockets were solid construction, sturdy enough to allow the tuning coils to be withdrawn and inserted with ease. The r. f. tube seemed to set up an audio howl when inserted in the shock absorbing type of socket. This phenomena disappeared when a solid socket was substituted.

Surely the sets outlined in Mr. Hull's article, and supplemented by friend W6HM, rule the ham waves.

Burton Synnot, W2FF, W2BBX
O. R. S., O. B. S.

Portable Station Licences

209 Pine Ave., Room 410,
Long Beach, Calif.

Editor *QST*:

Over a period of time, I have noticed that several of the amateurs use their own call wherever they go; in other words, they have been considering them as portable licenses.

Wherever possible, I have been telling them about the fact that their license carries a certain address and if they wish to use a portable license, they should write in and get a portable license, as they are available.

Innocently, they think that no harm is being done, but it may be well to warn amateurs that their station license must be used only at the address that is indicated on the license.

—Don C. Wallace, W6AM

For Those Enjoying Brass-Pounding

Missouri Pacific Railroad Co.,
St. Louis, Mo.

Editor *QST*:

RCD UR LTR 2DA WI NT DA OR MO
ABT WHY MI CK FR QST NT RCD - TNX
FR UR LTR - PSE NO IM NT A BP ES
LTR NRS QST HV ABT NIL XCPT LW
WV OR HI FREQ OM ES HAM ACCTS
- HV NT TM OR NTRST IN T SILEY
OM CY ES HAR IN LTR NRS QST - HV
BN NTRST GNL RDO NWS ES TNCL
DVLMT WI WCH QST HV HD GUD ES
IMPT PRT IN YRS GN BI - HV NT ANI
DSIR TO B BP ES NM TM FR IT EVN
HD I T DSIR - SO WI BST WSHS FR VY
HPY NWOYER -

IM URS VY TLY

W. J. Burton,
Assistant to Chief Engineer.

P. S.: If the above seems amateurish or causes you any unnecessary effort and perhaps mild disgust, you will know exactly how I feel with a copy of *QST*. But for those enjoying brass pounding I have no criticism.

SM

Here's 750 Volts Pure D. C. for S. W. Transmission

SEVEN hundred and fifty volts D. C.—perfectly rectified and filtered, free from hum and suitable for plate supply for transmission or for reception—is made available at low cost by the new S-M 324 power transformer. A big, husky sixteen-pound transformer. Two 750-volt, 150-milliamper secondary (centre-tapped 1500-volt winding), used with two 281 type rectifier tubes, will supply up to 150 milliamperes at over 700 volts. Price, \$25.00.

For use as filter choke in such a rectifier, the S-M 331 Unichoke is absolutely ideal. It utilizes the Clough resonance principle (under which it is licensed) to eliminate effectively the 120-cycle ripple—doing this more effectively with only 7 mfd. of condenser than do ordinary chokes with 8 to 12 mfd. Inductance at 110 milliamperes load, primary 2 henries, secondary 30 henries. Price, mounted in standard S-M case, \$8.00; open mounted (331-U) \$7.00.

Issue No. 7 of "The Radiobuilder" gives details of a circuit especially designed for economical production of pure D. C. at 750 volts. There are a few copies left—send for one right away if you haven't it.

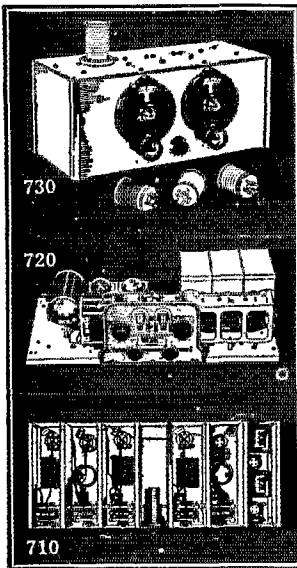
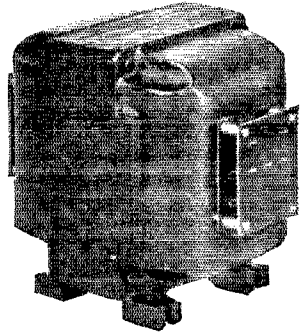

730 Round-the-World Four

The famous "Thrill Band" set—for long-distance broadcast reception; has S-M Clough-audio-system tone quality—splendid also for code. One screen-grid r.f. stage, regenerative (non-radiating) detector. Coils in kit tune from 17.4 to 204 meters; S-M 131X Coil (\$1.25) extends range to 350 meters, and 131Y coil (\$1.50) to 650 meters. Aluminum shielding cabinet included with 730 KIT \$51, or fully WIRED \$66. Also with 731 Adapter (plugs into any receiver, converting it to short wave) KIT \$36, WIRED \$46. 732 Essential Kit, \$16.50.

720 Screen Grid Six

Three screen-grid tubes in the r.f. stages, with shielded S-M coils, bring in distant stations on the next 10 kc. channel to powerful locals! New S-M standard of tone quality. Custom-built complete in 700 cabinet, \$102.00; complete KIT, with pierced metal chassis and antique brass escutcheon but without cabinet, \$72.50.

710 Sargent-Rayment Seven

Four screen-grid r.f. stages—a station on every 10-kilocycle channel right around its single-control dial (with five auxiliary vernier knobs)—equipped with the unequalled S-M Clough system audio amplifier—yet the 710 is only \$175 custom-built complete, or \$130 for KIT including aluminum cabinet.

New S-M Clough-System Push-Pull Transformers

Built on the Clough System, with curves flat from below 50 cycles to well above 5000—these transformers give to "push-pull" a new and really startling significance. And their prices—like their quality, are unbeatable!

257 Push-Pull Input Transformer, to operate from one amplifier tube into two 171A, 210, or 250 tubes. Price.....\$7.00

223 Push-Pull Interstage Transformer, to feed from two 112, 226, or 227 tubes into two 112A, 226, 227 or 171A, 210 or 250 tubes.....\$8.00

258 Tapped Output Impedance, to feed from two 171A tubes into any standard speakers.....\$5.00

248 Universal Output Choke, to feed out of two 210 or 250 tubes into one to six or more standard speakers; provided with several impedance-matching taps. It will handle over 20 watts without core saturation. Open-mounted.....\$7.00

228 (248 in case like 227).....\$3.00

Remember—S-M guarantees these push-pull transformers to have a finer frequency characteristic than any and all competitive types—bar none.

Are you getting *The Radiobuilder* regularly? No. 9 (Jan. 1929) describes new push-pull circuits, utilizing the new type of push-pull transformers described above. No. 7 (Nov. 1928) described in detail, with complete circuits, a 750-volt rectifying system using the new S-M 324 transformer illustrated above. Copies of both of these issues may be had without charge by QST readers as long as they last; use the coupon.

If you build professionally, by all means ask for information on the S-M Authorized Service Station proposition; its money-making opportunities are greater than ever.

SILVER-MARSHALL, Inc., 864 W. JACKSON BLVD.
CHICAGO, - - U. S. A.

Silver-Marshall, Inc.,
864 W. Jackson Blvd., Chicago, U.S.A.

....Send me, free, *Radiobuilder*
No.; also new S-M 24-page
catalog.

....Send full information on your
Service Station proposition.

Name.....

Address.....

(Continued from page 52)

A Radio Service Instrument

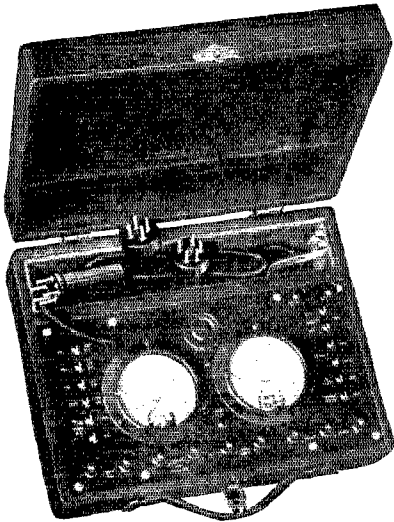

That Boosts Sales

The Jewell 199 A. C.—D. C. Set Analyzer solves the radio service problem perfectly. In conjunction with the Jewell Radio Set Analyzer Chart it enables service men to check radio receivers scientifically, thus getting the best possible results out of every receiver. Nothing is left to guesswork.

Prompt and effective elimination of customers' complaints is an important factor in building radio sales. Jewell Pattern 199 Set Analyzers in the hands of service men insure quick and effective adjustments of troubles.

Write for literature describing the Jewell Pattern 199 Set Analyzer and other high grade radio instruments.

Jewell Electrical Instrument Co.
1650 Walnut Street Chicago, Illinois

Manufacturers of a complete line of instruments for radio manufacturers' laboratories, transmitters, and service work.



29 Years Making Good Instruments

BELGIUM

The section was created on September 19, 1925, and on April 23, 1927 The Reseau Belge was recognized as the National Section. The President of the R.B. is Mr. Paul de Neck, 312 Rue Royale, Brussels.

BRAZIL

The section was organized on September 15, 1925. No national society has yet been recognized, but this will probably be done within a few months. Mr. Vasco Abreu, Riachuelo 80 C-4, Rio de Janeiro, is the president.

CANADA

The Canadian Section came into existence at the formation of the Union in Paris, on April 17, 1925, and, as provided by the Con-

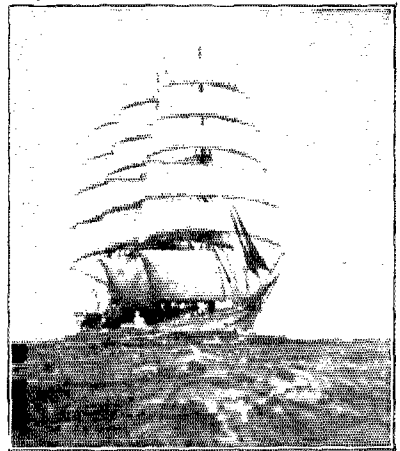

THE TRAINING SHIP "L'AVENIR"

stitution, consists of the Canadian Section of the American Radio Relay League, with the Canadian General Manager, Mr. A. H. K. Russell, as the president.

FRANCE

The French Section was also organized at the formation of the Union, on April 17, 1925. A national society, the Reseau Emetteurs Francais, grew out of the national section, and since June 20, 1925 has been the national section under the name of the R.E. F. The President of the R.E.F. is Mons. Reynt, Professeur au Lycee, 24 Rue des Vaupulents, Orleans.

GERMANY

The German Section was formed September 15, 1925. On September 1, 1927, the D.A.S.D. was formally recognized as the national society to take over the national

Faradon— an important factor

Faradon quality and dependability have contributed in no small measure to the present high standard of radio reception and transmission.

Producers of quality equipment recognizing this are utilizing Faradon Capacitors in achieving the high performance standard required.

The extensive experience of Faradon engineers is available to assist in taking care of special electrostatic condenser requirements not covered by the more than 200 types of Faradon Capacitors in regular production.

WIRELESS SPECIALTY APPARATUS CO.
JAMAICA PLAIN, BOSTON, MASS., U. S. A.
Established 1907

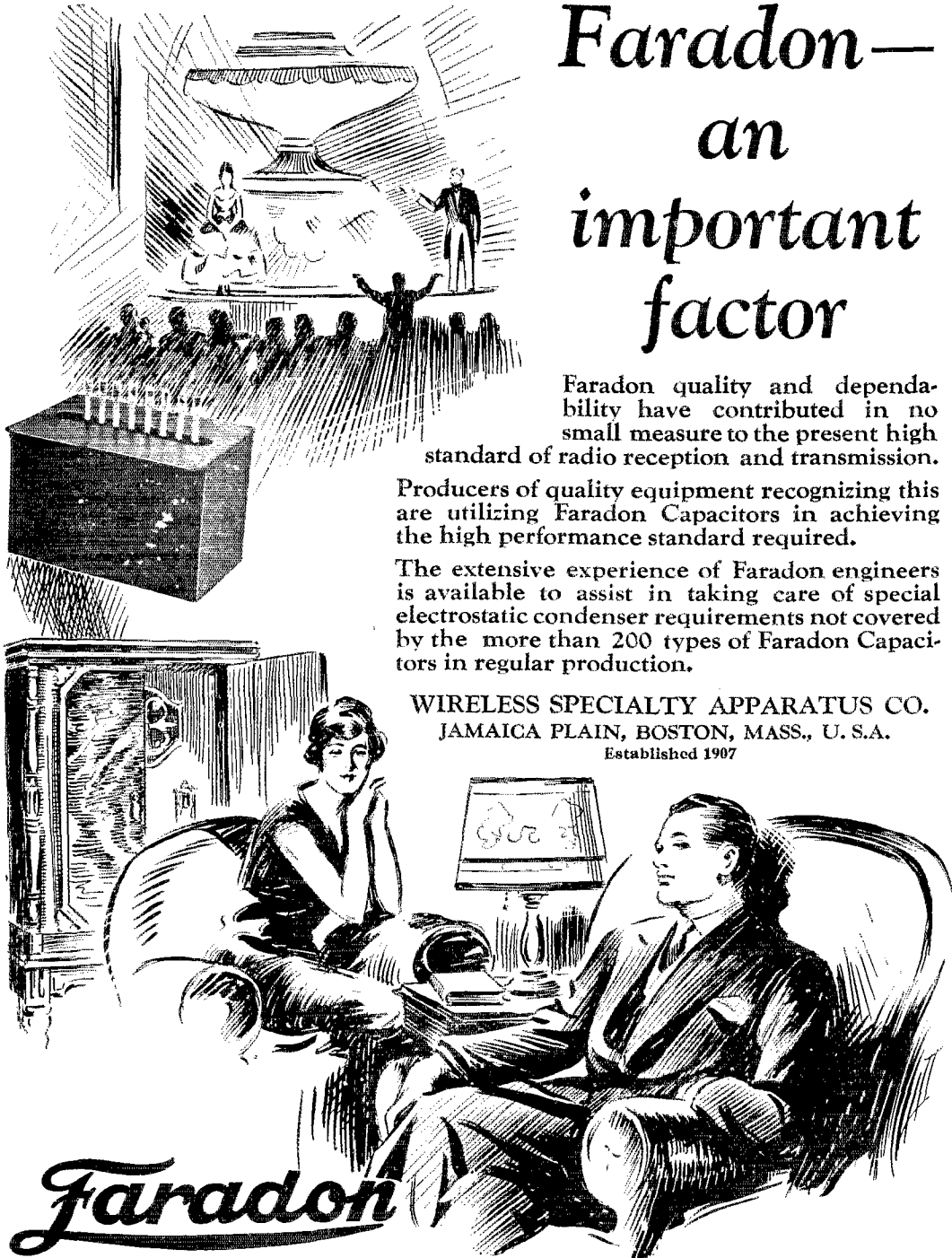

Electrostatic Condensers for All Purposes



*“Isn't it about time,
Dad, you eliminated
the adenoids”*

ANY set with inferior transformers has adenoids. Why not have your set give you what it is capable of—it's a mighty simple thing to eliminate the adenoids from your set—and to substitute true tones as given by AmerTran radio products.

No matter what your set is you have yet to hear the music as it is broadcast from the studio with all of the overtones and shadings from the lowest stop on the organ to the piercing note of the piccolo.

AmerTran audio systems will give you every tone broadcast—just as it is broadcast from the studio. A pair of De-Luxe transformers, or the superb power amplifier (push-pull for 210 tubes) and the ABC Hi-Power Box. No matter what AmerTran audio system you choose, your set will be free from adenoids. See your dealer or write to us.

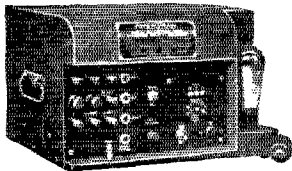

AmerTran ABC Hi-Power Box—500 volts DC plate voltage, current up to 110 ma; AC filament current for all tubes for any set. Adjustable bias voltages for all tubes. Price, east of Rockies—less tubes—\$95.00.

AMERTRAN

TRADE MARK REG. U.S. PAT. OFF.

AMERICAN TRANSFORMER COMPANY

Builders of Transformers for more than 29 years

41 EMMET ST.

NEWARK, N. J.

section. Herrn Oberst a. D. Otto Fulda, Blumenthalstr. 19, Berlin W. 57, is the present president.

GREAT BRITAIN

The British Section was formed at the Paris Conference, April 17, 1925. It eventually merged with the T. & R. Section of the Radio Society of Great Britain, and finally on December 14, 1927, the R.S.G.B. itself was recognized as the national section.

The president of the R.S.G.B. is Capt. Ian Fraser, 53 Victoria St., London, S. W. 1.

NETHERLANDS

The Dutch Section of the Union was formed on September 23, 1925. Out of this section grew a national amateur society, the N.V.I.R., and this took over the section in January, 1928. Mr. R. Tappenbeck, Hoogduin, Noordwijk-aan-Zee, is the President.

ITALY

This section was formally organized on March 4, 1926. In January, 1928, the A.R.I. was organized as the national section. Union matters in the A.R.I. are handled by a committee of three, consisting of Messrs. Gnesutta, Montu and Pugliese. Correspondence should be addressed to Mr. Pugliese, the Secretary, at via Borgonuovo 21, Milano, 2.

SOUTH AFRICA

Organization of the Union in South Africa was completed April 29, 1927, and on August 5, 1927, the South African Radio Relay League was recognized as the national section. The President is Mr. Joseph White, P. O. Box 7007, Johannesburg.

SPAIN

The Spanish section came into being on July 3, 1925. Here, as in France, the section later became a national amateur organization, and took the name of the E.A.R. Association. Final action recognizing the E.A.R. Association as the national society was taken on October 14, 1926. The President is Mr. Miguel Moya, Mejia Lequerica 4, Madrid.

SWITZERLAND

The Swiss Section was formed September 10, 1925, but has never voted on the matter of designating some national amateur society as the national section. Due to heavy restrictions in Switzerland it is doubtful if any such national society exists to be recognized.

The President of the Section is Dr. Walter Merz, Chateau de Bumplitz, Berne.

UNITED STATES

The United States Section was created at the Paris Conference, April 17, 1925, and under the terms of the original Constitution it was specified that the American Radio Relay League, Inc., should constitute the national section for the U.S. The President of the A.R.R.L. is Mr. H. P. Maxim, 1711 Park St., Hartford, Conn.

Stop "FOOLING" with RADIO!

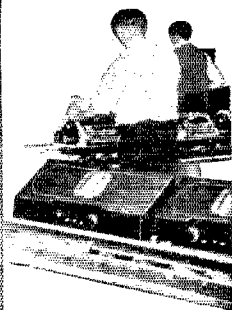
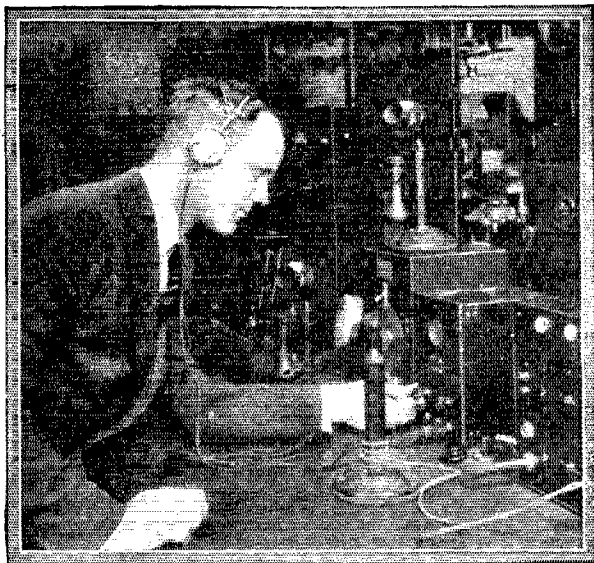

RADIO amateurs! Don't treat radio as a mere plaything! Make it pay you real money. Thousands of fellows are doing it. So can you. A little commercial training is all you need to give you money-earning confidence and ability. Get this training in spare time at home . . . through the marvelous home-laboratory course sponsored by the Radio Corporation of America. The FREE Radio Book tells all about it.

If you've been playing around with radios and have a pretty fair knowledge of it, you can now easily and quickly lift yourself into the real money class. For a marvelous new home-laboratory course in Radio gives you just the added commercial training you need for big-time radio success. As a result of this course many men formerly in poorly paid positions are now earning as high as \$100 to \$250 a week in Radio work!

Home-Laboratory Training

With this advanced commercial training you get the "how" as well as the "why" of every phase of radio work and technique. Only an hour or so a day—in spare time—is all you need to put the finishing touch to your radio experience. As part of your course, you receive absolutely free of extra charge—an outlay of fine apparatus.

Training backed by the Radio Corporation of America

Our graduates are in big demand everywhere. They enjoy greater success because they're posted right-up-to-the-minute in *everything* in Radio. Radio's progress each year is measured by the accomplishments of the great engineers at work in the research laboratories of the Radio Corporation of America. This Radio organization sets the standard for the industry, and because it sponsors every lesson in the course you are assured of the most complete

authoritative and up-to-date radio training in the world!

Money Back If Not Satisfied

The lessons prepare you for success in all phases of radio—manufacturing, servicing, selling, ship and shore broadcasting, Television, Photoradiograms, and radio equipment. A signed and sealed agreement assures you of complete satisfaction upon completion of the training—or your money will be promptly refunded! So you cannot lose a single penny!

Read This Free Book

It tells you all you'd like to know about Radio. Its 50 pages and photos describe Radio's opportunities for adventure and success. It describes in detail the famous training that has enabled us to place thousands of our students in fine commercial positions, usually from 3 to 10 days after graduation! Read this great book . . . it may mean the turning point in your life! Mail the coupon now—the book is absolutely free! RADIO INSTITUTE OF AMERICA, Dept. ST-2, 326 Broadway, New York, N. Y.

RADIO INSTITUTE OF AMERICA
Dept. ST-2

326 Broadway, New York, N. Y.

Gentlemen:

Please send me your big FREE 50-page book which tells about the opportunities in Radio and about your laboratory-method of guaranteed radio instruction.

Name _____

Address _____

Fixed and Adjustable Resistors

for all Radio Circuits



Bradleyunit-B

RADIO manufacturers, set builders and experimenters demand reliable resistors for grid leaks and plate coupling resistors. For such applications Bradleyunit-B has demonstrated its superiority under all tests, because:

- 1—Resistance values are constant irrespective of voltage drop across resistors. Distortion is thus avoided
- 2—Absolutely noiseless
- 3—No aging after long use
- 4—Adequate current capacity
- 5—Rugged, solid-molded construction
- 6—Easily soldered

Use the Bradleyunit-B in your Radio Circuits

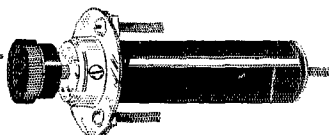

Radiostat

This remarkable graphite compression rheostat, and other types of Allen-Bradley graphite disc rheostats provide stepless, velvet-smooth control for transmitters, scanning disc motors and other apparatus requiring a variable resistance.

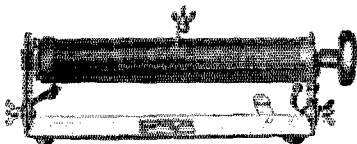

Laboratory Rheostat

Type E-2910 — for general laboratory service. Capacity 200 watts. Maximum current 40 amperes. A handy rheostat for any laboratory.

Write for Bulletins!

ALLEN-BRADLEY CO., 277 Greenfield Ave., Milwaukee, Wis.

Allen-Bradley Resistors

In previous issues of this magazine we have referred to the signals of XEB4WK, the Belgian training ship "L'Avenir." Through the courtesy of the Reseau Belge we are able to print the following extremely interesting photos and description of this all-amateur installation.

XEB4WK

By EB4WW

L'AVENIR", or XEB4WK, is a large four-masted sailing training ship, one of the finest of her kind afloat. On each trip she carries, in addition to cargo, about 70 midshipmen who are learning how to become licensed marine officers for the mercantile shipping board in Belgium. It might be pointed out that there is no auxiliary power of any kind, sails alone being used for propulsion.

EB4FT and myself thought it would be interesting to put on board an experimental amateur set, and after obtaining the necessary permission we designed, and installed the transmitter and receiver shown in the photograph. The set was built by Mr. Velghe.

The first circuit tried out was a Mesny (push-pull) two-tube, but it resulted in too much QSSS with all that maze of wire stays and halyards only several feet from the antenna. It was almost impossible to read when the wind was blowing.

The cure was a M.O.P.A. circuit, which after some changes emerged as shown in

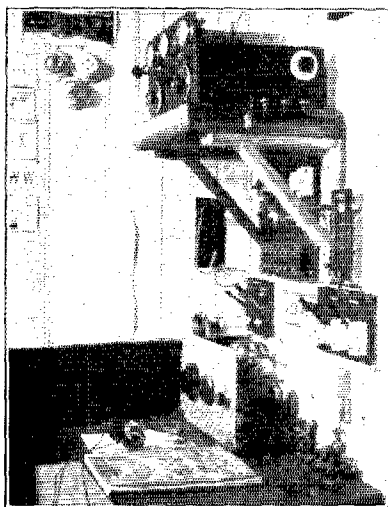

THE OPERATING ROOM AT XEB4WK

the circuit diagram. Best results were secured with a very small coupling capacity direct to the oscillator plate. The capacity used to balance the amplifier was quite critical in adjustment. Grid bias for the amplifier would have been very useful, but since the set is battery operated, could not

Reap Big Dividends from this Investment in Tone Quality

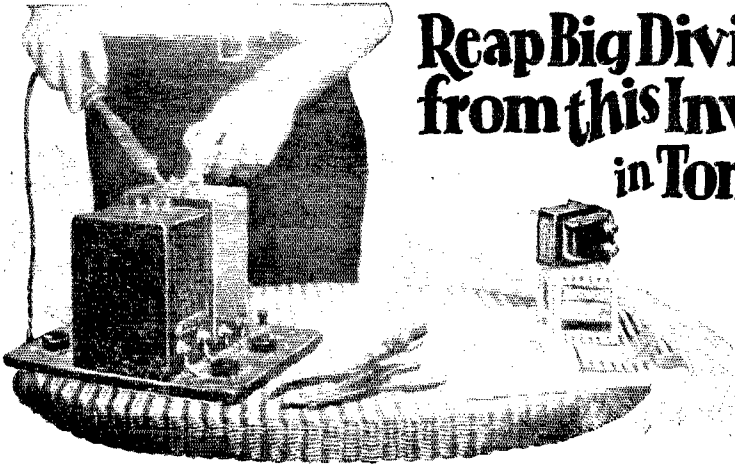

A Thordarson Power Amplifier (Home Constructed) Will Transform Your Radio Into a Real Musical Instrument

WITH the insistent demand for quality reproduction, power amplification has become a vital radio necessity. Today, it is hard to find a radio set manufacturer who does not employ one or more power tubes in the output stage of his receiver.

There is no need, however, for you to discard your present radio instrument in spite of the fact that it is out-classed by newer models with power amplification. You can build a Thordarson Power Amplifier which, attached to your receiver, will provide a fullness and richness of reproduction that will equal or surpass the finest offerings of the present season.

Thordarson Power Amplifiers are exceedingly easy to assemble, even for the man with no previous radio experience. Only the simplest tools are used. Specific instructions with clear-cut photographs, layouts and diagrams insure success in home construction.

Whether your present receiver is factory made or custom built one of these amplifiers may be attached with equal ease. In fact, most Thordarson Amplifiers require absolutely no changes in

the wiring of the receiver itself, attachment being made by means of a special plug which fits the last audio socket of the receiver.

Thordarson Power Amplifiers for the home constructor and professional set builder range from the simple plate supply unit up to the heavy-duty three stage units employing the 250 type power tube in push-pull arrangement. These power amplifiers cover the requirements for every purpose and every pocket-book. They may be used with any type of horn, cone or dynamic speaker.

With a background of over thirty-three years manufacturing quality transformers, it is only natural that so many manufacturers of receiving sets of undisputed superiority have turned to Thordarson as the logical source of their audio and power supply transformers. The discriminating home constructor will do well to follow the lead of these manufacturers when buying his power amplifier.

Write to the factory today, enclosing 25c for the new "Power Amplifier Manual"—just off the press

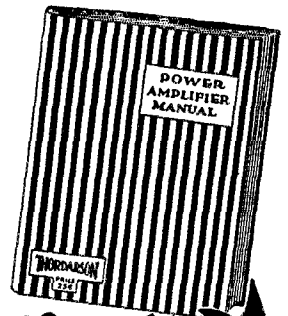

New!

No Amateur or Professional Set Builder Should Be Without This Book—

"POWER AMPLIFIER MANUAL"

A simple, yet complete, treatise on the subject of audio and power amplification, including full information on building, servicing, and testing power amplifiers in general. Also contains detailed specific construction data on twelve individual power units, with clear-cut layouts and diagrams of each.

25c

Send 25c in Cash or Stamps for This New Book—
Just Off the Press!

MAIL THIS COUPON TO-DAY!

THORDARSON ELECTRIC MANUFACTURING CO.

500 West Huron Street, Chicago, Illinois

Gentlemen: Please send me your new "Power Amplifier Manual" for which I am enclosing 25c.

Please send me free of charge your instruction sheet on the amplifier I have checked below:

171 Single 171 Push-Pull 210 Single 210 Push-Pull (1 Stage) 210 Push-Pull (2 Stage) 250 Single (1 Stage) 250 Single (2 Stage) 250 Push-Pull (3 Stage) 210 Phonograph Amplifier

Name

Street and No.

Town State

2596 P

THORDARSON RADIO TRANSFORMERS

SUPREME IN MUSICAL PERFORMANCE

Are We Right?

You should have at least two of them — one for your complete 1928 file of copies, and one for each 1929 issue as published.

Keep them as a unit in a

QST Binder



Note the wire fasteners. Unnecessary to mutilate copies. Opens and lies flat in any position.

One-fifty each
postpaid

A binder will keep your QSTs always together and protect them for future use. And it's a good-looking binder, too.

QST

1711 Park St., Hartford, Conn.

be spared. The set seems to function quite satisfactorily with grid leaks.

One TB-04/10 Phillips valve is used as the oscillator, and two for the amplifier (only one being shown in the diagram, since the tubes are operated in parallel). These tubes are rated at 10 watts output.

Power supply is secured from a very fine 480-volt storage battery donated by the Tudor Accumulator works.

The antenna is a third harmonic Marconi, and like the antenna used by Mr. Schnell on the "Seattle" some years ago, was erected in the "least worst" position. A good ground was secured from the steel hull of the ship itself.

The original receiver was a Schnell with one audio, but signals were so unsteady—due to the proximity of other wires—that an aperiodic coupling tube was added, as shown. Signals are not stronger with this, but are steadier.

Our pride in this set is the switch-over system. A single throw accomplishes the following: Changes antenna from transmitter to receiver, turns off the transmitter

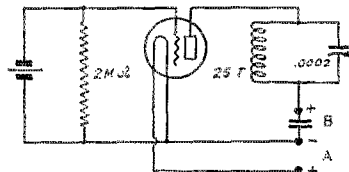

CRYSTAL RESONATOR CIRCUIT

filaments gradually, and brings on the receiver filaments gradually, cuts off the key, and switches the negative B battery from the transmitter to the receiver.

We believe that "L'Avenir" is the first vessel of her type equipped with a real amateur short-wave transmitter and operated by a ham. She is now on an extended cruise to Martinique, from where she will go to Tampa, Florida, where it is hoped that many American hams will visit her. A splendid welcome will be given anyone coming on board.

The call XEB4WK is used, the note being d. c. on a wavelength of 32 meters. All reports and cards may be sent to the Reseau Belge, 11 Rue du Congres, Brussels, Belgium.

INTERNATIONAL PREFIXES

Slowly, various governments are specifying the amateur prefixes to be used under the requirements of the 1927 Radio Conference of Washington. Again, we wish to urge upon amateurs everywhere that they advise us immediately upon receipt of authentic information as to the prefix to be used for their countries. Prefixes have already been designated for some nine countries, as follows:

Australia	MH
Canada	VE
Cuba	CM

The phantoms of music now become REALITY!



Tone!

"X" Line Transformers
 Type AX straight audio amplification, list price \$6.00
 Type BX Push-pull input unit, list price ... \$6.50
 Type CX-171 Push-pull Output transformer, for 171 or 250 power output tubes for cone speaker, list price \$6.50
 Type DX, same as CX except for 210 and 112 power tubes, list price ... \$6.50
 Type HX Push-pull Output for 171 or 250 Power output tubes to match the impedance of moving coil of Dynamic loud speaker, list price ... \$6.50
 Type GX same as HX except for 210 and 112 power tubes, list price ... \$6.50
 Type E output choke to match impedance of the various type power tubes, list ... \$5.00

"A" Line Transformers
 (Similar to "X" line but with special core metal to give slightly better curve)

Type A straight audio amplification, list price \$10.00
 Type B Push-pull input transformer for all tubes, list price ... \$12.00
 Type C-171 Push-pull Output, for 171 or 250 type power tubes with cone speaker ... \$12.00
 Type 4-210 same as C except for 210 and 112 power tubes ... \$12.00
 Type H-171 Push-pull Output for 171 or 250 power tubes for Dynamic speaker ... \$12.00
 Type G-210, same as type H except for 210 and 112 tubes, list price ... \$12.00
 Type R Plate Impedance for use as a choke to prevent oscillation and for impedance coupled amplifiers, list, \$5.00

INSTRUMENTS—golden notes formerly lost to radio now come through broadcast receivers in full tonal beauty. No longer does the bass viol come in thinly on overtones alone—no more do the shrill notes of the piccolo at top register die away in a shrill, reedy absurdity. The modern radio has TONE!

ful amplification of low notes and an accurately divided secondary insures practically identical frequency characteristics. There are Sangamo Push-pull Output Transformers to match the impedance of the various type power tubes and special Output Transformers for dynamic speakers.

In the Sangamo line there are transformers which permit set builders and manufacturers to produce the real tone fidelity. Are you ready for us to send you the data?

Sangamo Condensers

Molded in Bakelite—unchanging value under all conditions of service.

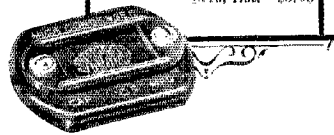

SANGAMO ELECTRIC COMPANY

Springfield, Illinois

For 29 years preeminent manufacturers of electrical precision instruments

A NEW RECTOBULB!

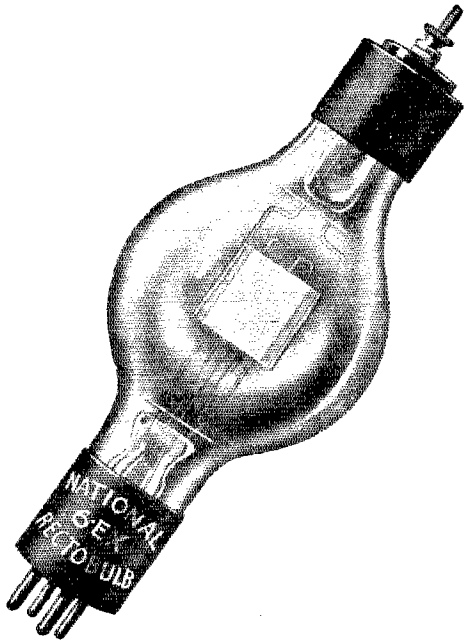

The Practical Rectifier

to meet the exacting requirements for the Amateur Xmitter of 1929. Whether you use 7½ watters, the 852 or the 204A. Maximum Inverse Voltage70000 v Voltage Drop (approximate)15 v Maximum Peak Current1 ampere An Oxide coated Cathode is heated by an internal, coil filament; this filament takes 10 volts and draws only 1.7 amps.

The plate connection is at the top and a UX base at the bottom and fuses furnished with each tube.

These tubes are IDEAL for the power amplifier sets.

Price \$10 each. Postpaid in U.S. if cash accompanies order; avoid delay in the receipt of your PAIR by placing your order NOW.

We are now repairing the following tubes: 203a (Thoriated) \$19 204A (Thoriated) \$75; WE211 (Oxide) \$16.50 and prepared to give immediate service on these type tubes.

Midwest Representatives

CHIRAD and HENRY RADIO SHOP

NATIONAL RADIO TUBE CO.,
3420 18th St., San Francisco, Cal.

Denmark	OZ
Mexico	X
New Zealand	ZL
Portugal	CT
Salvador	YS
United States (territorial)	W
" " (possessions)	K

Make a list of these new prefixes and put it somewhere in sight on the operating table. You will be hearing them from now on. Additions will be listed in this department as fast as they become known.

Belgian Section Report

By W. Keeman, Traffic Mgr., R. B.

DX conditions both on 20 and 40 meters have been very bad lately, with but a few exceptions. During the latter part of November not a single W was heard on 40 meters for weeks! Some EU's and A's (especially AG's) were reported with good strength. After a series of tremendous gales which swept over Europe recently, these contacts got slightly better. On the whole, however, latter November was a very bad month for that part of the human race known as Dutch hams. On 10 meters WIN and BU have heard a few W stations; W2JN was heard on October 28 QRK R3-4 with bad QSS.

At last it appears that we will get our long-desired licenses, only the 160-meter band remaining closed to us. Full details are not yet available, but will be published as soon as the regulations are issued.

We are now endeavoring to transfer all local phones to the 80-meter band, in order to reserve 20 and 40 for dx work. We hope that other countries will follow this example.

If any foreign station wants the cooperation of Dutch hams for tests, we will always be pleased to publish his skeds in our weekly organ. Please write to the Traffic Department of the N.V.I.R., c/o Mr. A. H. L. Fortuin, Vlamingstraat 37, The Hague, Holland.

Denmark Section Reports

By Helmer Peterfen, OZ7SP

We have the pleasure of informing our foreign friends that the new regulations for this country have at last appeared from our General Directory for Post and Telegraph Service. The regulations, based of course on the regulations carried by the Washington Convention of 1927, are as follows:

Frequency Bands	
Kilocycles	Meters
1730	173.4
1830	163.9
1930	155.4
3880—3990	73.3—75.2
7010—7290	42.8—41.15
14020—14380	21.4—20.86
28030—29970	10.7—10.01
56100—59900	5.34—5.01

Amateur Band "De Luxe" Receiver!

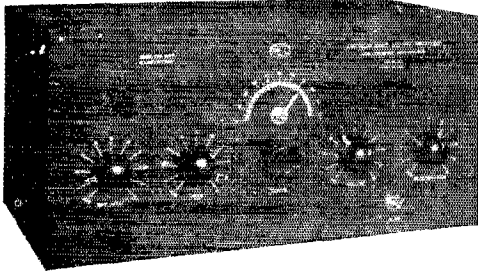

Screened Grid R. F. — Detector — Tuned Peak Audio—Combined with full spread tuning for each new 1929 Amateur Band. A truly Great Receiver which every Ham will want to own. See Nov. QST, page 9.

The Radio Engineering Laboratories Cat. No. 217 Amateur Band De Luxe Receiver may be purchased as a complete kit or else any of the parts used in the receiver may be secured individually. The wiring diagram below gives full explanation of the circuit and the material necessary. The illustration on the left shows this receiver mounted in a metal case. The complete kit of parts includes the metal case and the neatly engraved aluminum front panel, the dimensions of which are 9" x 19" front x 10" deep.

The kit price on the REL Cat. No. 217 Receiver is \$58.00. If you so desire, REL can supply this receiver completely built and tested at a slight additional cost.

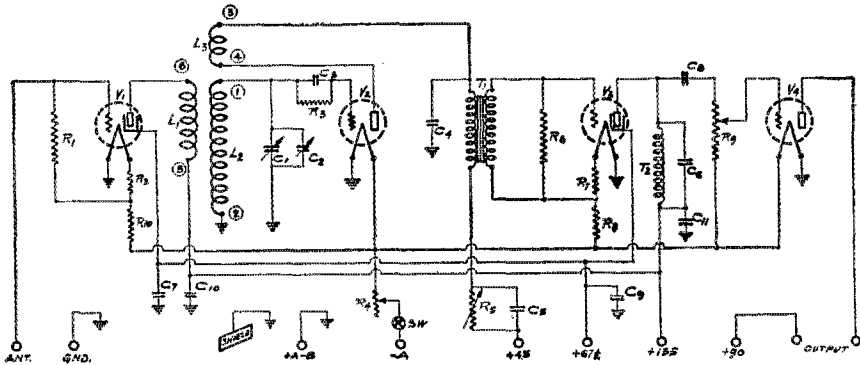

L1, L2, L3—One complete set REL Cat. No. 182 coil kit (This contains three coils and the base) designed to cover 3500 to 7000 and the 14,000 KC bands.
 C1, C2—One REL Cat. No. 187E secondary tank variable condenser with special movable vernier for obtaining full scale spreading for each band.
 C3—0001 mfd. Fixed condenser

C4—002 mfd. fixed condenser
 C5—5 mfd fixed condenser
 C6—01 mfd. fixed condenser
 C7—1mfd. fixed condenser
 C8—006 mfd. fixed condenser
 C9—1 mfd. fixed condenser
 R1—10,000 ohm metallized grid leak
 R2, R7—10 ohm strip resistances
 R3—10 meg ohm grid leak
 R8, R10—5 ohm strip resistances

R4—10 ohm rheostat
 R5—50,000 ohm variable resistance
 R6—1 meg ohm grid leak
 R9—500,000 ohm variable potentiometer
 T1—3 to 1 ratio audio transformer
 T2—One REL Cat. No. 217 tuned audio choke—\$9.00
 V1, V3—6X4-222 tubes
 V2, V4—6AV6-201A or 112A tubes

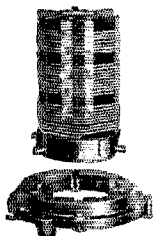

A MATEUR Band Coil Kit—Three plug-in coils and one base constitute the necessary inductance for tuning the three popular amateur channels, that is, the 20, 40 and 80 meter bands. The coils have been designed to operate in conjunction with REL Cat. No. 187E combined tank and vernier type condensers. Any similar type of condenser may be employed, the tank capacity of which should be 175 mmds. maximum, and the vernier capacity should be approximately 20 mm.ds. maximum.

The successful spreading out of each of the new 1929 narrow bands can only be accomplished by using these coils in conjunction with the REL condenser mentioned. This coil kit is adaptable to various other popular short wave circuits.
Cat. No. 182 Amateur Band Coil Kit. Price \$10.00

COMBINED Tank and Vernier Condenser—A condenser of this type is absolutely essential in all receivers which are designed to give full spread tuning of each of the new 19.9 bands. Imagine the enormous benefits derived by having these small channels spread out over the full scale of the condenser dial. You, no doubt, have already realized that an instrument such as this is an absolute necessity. These condensers being of exceptional rugged construction will be found very desirable for high frequency receiver work.
 The large semi-variable capacity is rotated by means of the bakelite disc. This disc may be notched so that the locking device supplied will fit these notches. In this manner, it will be easy to always return the large capacity to a setting previously employed. The small vernier condenser is then used to obtain full spread tuning. Adjustment of the vernier condenser is made from the front whereas the adjustment of the large tank condenser is made at the rear. This need only be set when the plug-in coils are interchanged when shifting from one band to another.
Cat. No. 187E condenser..... Price \$6.25

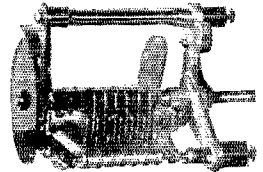

Have you received your REL 1929 booklet? It's ready now.
 When you rebuild, be sure to do it the REL way.

RADIO ENGINEERING LABS., 100 Wilbur Ave., L. I. City, New York, U.S.A.

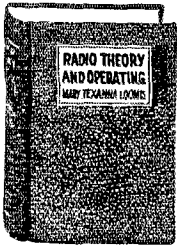

TELEVISION
 RADIO CONSTRUCTION
 RADIO REPAIRING
 RADIO SERVICING
 MARINE RADIO OPERATING
 RADIO COMPASS WORK
 LAND RADIO OPERATING
 BROADCASTING
 AIRWAYS COMMUNICATIONS
 RADIO ACCOUNTING
 MESSAGE FORMS
 1929 RADIO LAWS
 JUNIOR ENGINEERING

The above subjects and many others thoroughly covered in the best radio text and reference book ever produced.

"RADIO THEORY AND OPERATING"

392 Pages 300 Illustrations

By Mary Texanna Loomis, President, and Lecturer on Radio, Loomis Radio College. Member Institute of Radio Engineers.

Fourth Edition—Thoroughly Revised.

Used by all the Government radio schools, nearly all the radio schools in U. S. and Canada and over 200 universities, colleges and high schools.

Flexible binding—Price \$3.50

For sale by practically all bookdealers this and foreign countries. Or sent, postage paid, on receipt check or money order.

LOOMIS PUBLISHING COMPANY

Dept. 5 Washington, D. C.

Look Here Hams!

MONEY SAVERS

Thordarson 150 Watt Power Transformer rated at 800 volts, 11 volts center tapped and 4 volts no center **\$5.95**

Thordarson 60 Henry Double Chokes, 30 henrys each choke, 150 M. A. **\$4.95**

Thomas Andrews 20 mfd. Condenser Block, taps at 4, 6, 5, 2, 2, 1, 1 and .1 mfd. 400 volts working voltage . . **\$3.95**

Erla 1,000 cycle peaked audio transformers **\$.95**

The above transformer, choke and condenser combination will make an ideal power supply for a crystal oscillator.

The full 800 volts can be utilized by disregarding the center tap and connecting the two outside terminals to a bridge chemical rectifier or thermionic half wave rectifier.

The condensers can be connected in series giving 800 volt working voltage. 1,000 cycle audios are a necessity in these days of heavy qrm.

The peak can be tuned by a variable .0005 mfd. condenser shunted across the secondary.

RADIO EQUIPMENT CO.

W9DFW

549 S. WELLS ST.

CHICAGO, ILL.

The waves sent out must be as free from harmonics and as constant in frequency as the state of the art permits. Use of raw or insufficient rectified AC for plate supply and keying by spacing wave is prohibited.

Calls, in the future, will consist of the prefix OZ followed by one figure and not more than three letters. Present calls may be kept unaltered, except that the intermediate ED is replaced by the prefix OZ. If a shorter call is wanted, it may be changed upon application for a call consisting only of OZ, one figure, and one letter, as for instance, OZ2C. Applications for short calls had to be in the hands of the G.P.T.S. before December 20, 1928.

All general regulations carried by the International Radio Convention must be maintained.

Conditions in Denmark are not so good at present. Only Spain, Italy and the U.S. S.R., with now and then a single British station, are heard. 0000 to 0100 GMT (7 P.M. to 8 P.M. E.S.T.—Ed.) seems to be the best hour for WQSO's.

To help Danish hams prepare for the 1929 conditions, E.D.R. (the national amateur society) has taken up the work of calibrating wave-meters. Further, as a good many Danish transmitters are going to have their sets crystal-controlled, the E.D.R. is making arrangements to supply the hams with crystals at moderate prices.

The Danish expedition ship "Dana" is now in the Pacific Ocean, and has on board the short-wave station OXQ, operating on 37 and 23 meters. QSO's will be welcomed, and reports are solicited.

The year 1929 is here; we wish all our foreign friends a happy new year.

German Section Reports

By E. Reiffen, Sec'y, D. A. S. D.

The DX-crowd says that conditions have not bettered materially in the last month. Distance QSO's on 40 and 30 were good in part. On 20, as in the preceding months, the conditions were very changeable.

According to the new German regulations, no German ham may send with a.c. after January first, 1929. It would be desirable if all countries were to set up such a prohibition.

The German short-wave transmitters are very much hindered by the long hours of transmission indulged in by the broadcasters. A favorable solution of this has been found by a few DX-amateurs who during the day use a low-power transmitter of 5 watts or less, which cannot interfere with a B. C. receiver in the next room. Even with 5 watts many QSO's up to 3500 km. have been made.

For the most part, German amateurs are still unlicensed, but the license matter is finally in a developmental stage, and we count on a decision being made early in 1929.

The DX-transmitters have rebuilt their sets for 1929, and a few also are becoming

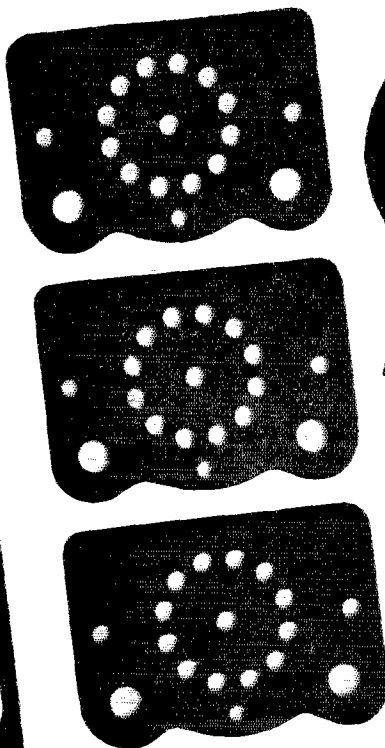
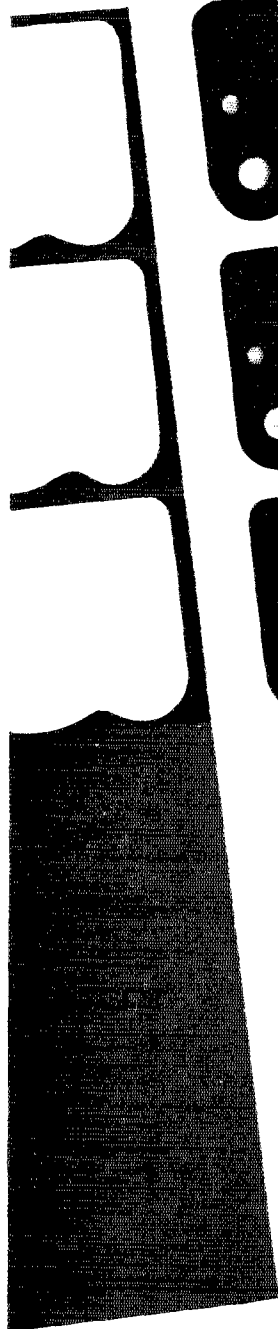

GOOD INSULATION *Promptly and Accurately!*

LEADING radio and electrical manufacturers have regarded Formica as their source of supply on insulating parts for many years.

Amateur receiver and transmitter builders have likewise found Formica to offer panels, tubes, rods and similar insulating parts that are always dependable, well finished and good-looking.

Ask for Formica when you buy insulation.



The FORMICA INSULATION CO.

4620 Spring Grove Ave.

Cincinnati, Ohio



Martin's Latest and Greatest Bug
THE Great New VIBROPLEX

Reg. Trade Marks: Vibroplex, Bug, Lightning Bug

No. 6

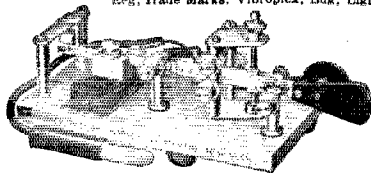

Japanned Base \$17
 Nickel-Plated \$19

The smoothest, easiest-working bug on the market not too fast, but just right. Works where others can't.

Famous Improved Vibroplex

Used by tens of thousands of operators because of its ease and perfection of sending.

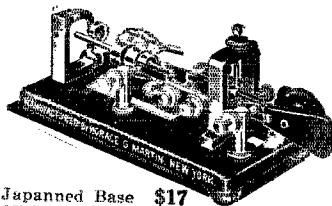

Japanned Base \$17
 Nickel-Plated \$19

Special Radio Bug

Equipped with Extra Large, Heavy, Specially Constructed Contact Points for direct use without relay **\$25**

Be sure you get the Genuine Vibroplex. The Vibronlex Nickel-plate is your protection. Remit by Money Order or registered mail.

THE VIBROPLEX CO., Inc. 825 Broadway New York City
 Cable Address: "VIBROPLEX" New York

interested in the 10-meter tests. The D.A.S.D. has offered two transmitting tubes as a prize for the first 10-meter QSO between Germany and America.

The year 1928 is now over. We wish all transmitting amateurs a Happy New Year, best DX on all bands and a good amateur spirit. 73 to all.

British Section Reports

By the Radio Society of Great Britain

Outstanding during the month has been the fine progress made on the 28,000-kc. band.

On October 21st Mr. J. W. Matthews, G6LL, established the first British contact with America, thus winning the new Wortley Talbot cup presented by Dr. Wortley Talbot, G6WT.

Later on the same day Mr. Scott, GW17C, and Mr. E. J. Simmonds, G2OD, established two-way communication with the States.

These performances were eclipsed on the following Sunday, October 28th, when Mr. Rodman, G2FN (late AI2KT) was in communication with W6UF using only 8 watts input!

Since that time several British stations have been heard, or have communicated with the States, and all ears are now being turned to the 28,000 KC signals from Australia.

It is found that DX signals on this band are best between 1300 and 1900 GMT (8AM -2 PM, E.S.T.—Ed.) and amateurs in all European countries are asked to listen for British stations calling on this band.

The type of aerial favored by our pioneer men is a vertical antenna of the half-wave Zeppelin type.

Crystal control is used by most of our DX amateurs, whilst the low-power men are either using crystal control or MOPA. All British stations are required to have accurate means of checking their transmissions, and in this connection the crystal resonator is found to be of very great use. The circuit for this is shown in the accompanying figure. The crystal is connected between grid and filament and various coils and condensers used to tune the circuit to resonance. A milliammeter in the high-voltage supply will be found useful. This should show a very small current when the crystal is oscillating. The crystal oscillates on its fundamental, and if the "resonator" is coupled to the receiver the harmonics can be picked out. The resonator can also be coupled to the heterodyne wavemeter and later checked before each transmission.

Several reliable British firms have commenced the manufacture of low-priced crystals, and we shall be pleased to put any amateur in touch with these companies.

No British stations are now working on 3500 KC. At a recent meeting of the R. S. G. B. it was decided to speak in terms of frequency, and not in wavelengths.

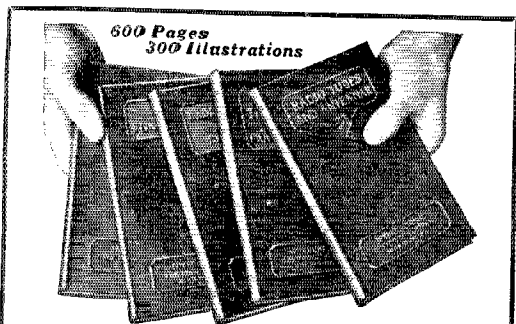

Everything you want to know about RADIO

Every branch of radio knowledge is covered in this complete 6-volume Radio Library. For everybody in the radio field—mechanics, operators, inspectors, service men, salesmen, owners of radio stores. Written by such experts as Harry F. Dart, E. E. Member, Institute of Radio Engineers; C. H. Vose, B. S. in E. E., of the Radio Engineering Dept. of the General Electric Co., and other prominent Radio Engineers. Gives you the whole science of radio in clear, understandable English. Handsomely bound, pocket-size volumes, stamped in gold. Includes Picture Transmission and Reception. Send the coupon with \$7.50 in check or money-order.

Money back if not satisfied.

International Correspondence Schools
 Dept. 613-C, Scranton, Pa.

I am enclosing \$7.50 for which please send me your five-volume RADIO LIBRARY. It is understood that I may return the books in five days and you will refund my money if I am not satisfied.

Name

Address

NOW! AN ELKON DRY RECTIFIER for PHILCO POWER UNITS

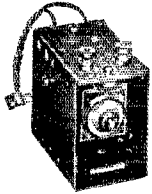

Type BNK for replacing the acid jars in Balkite Types N and K Trickle Chargers

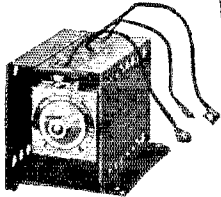

Type BJ for replacing the acid jars in Balkite Type J chargers

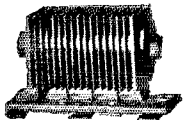

Type M-16 for replacing the rectifiers in 11 makes of "A" Eliminators and 3 Ampere chargers



Type V-4 for replacing the rectifiers in 6 makes of trickle chargers

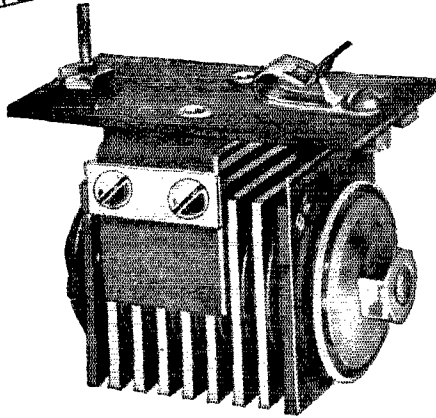

THIS new Elkon all-dry metallic rectifier Type U-P-3 is so designed that it replaces the wet jar rectifiers designated as Philcatron A and Philcatron AA used in Philco Trickle Chargers, Philco "A" Powers and Philco A and B combinations.

Very simple to attach, two wires to connect. May be done in a minute by anyone. No liquids to bother with—no attention—just satisfaction.

Do not be surprised at its small size—for in its sturdy couples are packed thousands of hours of perfect service. Its compactness is one of the reasons for its efficiency. The U-P-3 is a fitting member of the Elkon family of dry-metallic rectifiers. Visit your dealer today.

ELKON, Inc.
Division of P. R. Mallory & Co.
350 Madison Ave., N. Y. C.

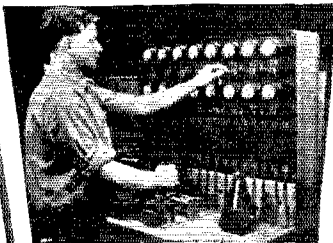

Not a music lesson but one of the many accurate processes of testing Elkon rectifiers

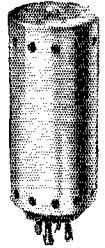

5000 hour type FBH rectifier for replacing BH type tubes in "R" eliminators. Replaces fragile 1000 hr. tubes.

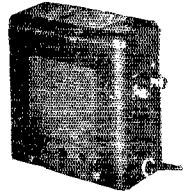

Type E Tapering Charger. Maximum charging rate lamp. Dry. No moving parts. Long life. Ideal for dynamic speakers.

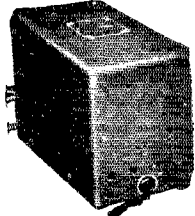

3 Ampere Charger. Dry, noiseless, no moving parts. Has tapering feature—long life. For radio or auto batteries.

Dry, high-capacity condensers. Capacities from 750 to 2000 microfarads.



ELKON, Inc., Dept. 18
Please send me complete information on the
Elkon Radio Products.
Name _____
Address _____
350 Madison Ave., N. Y. C.

MORE RADIO HOURS WITH ELKON RADIO PRODUCTS

A Promise for 1929

During 1928 Hardwick, Field, Inc. built the best resistors brains and materials could produce. If money can buy a better resistor in 1929, Hardwick, Field, Inc. promise to produce it.

That is why so many leading manufacturers are buying the Har-Field Resistor in ever-increasing quantities. They recognize in its unusual dependability, a constant endeavor to build the perfect resistor.

Some of the more prominent concerns now using Har-Field Resistors are listed below:

Western Union
Telegraph Co.
Jensen Radio Mfg. Co.
Spartan Electric Co.
Samson Electric Co.
Philadelphia Storage
Battery Co.
Colonial Radio Corp.

Stromberg-Carlson
Tel. Mfg. Company
Kaiser Radio Corp.
American Transformer
Company
Farrsted Products Co.
Zenith Radio Corp.

[Tell us about the resistor you want. If we can't supply you from our standard range of sizes, we shall be glad to make up samples for you with prices]

HARDWICK, FIELD, INC.

SALES OFFICE
122 Greenwich St.
New York City



FACTORY
215 Emmet St.
Newark, N. J.

YAXLEY

Radio Convenience Outlets
Cable Connector Plugs

Rheostats Potentiometers
Jacks Switches
Resistance Units

For greater convenience in receiver operation and dependability in set construction make up your list of parts and accessories from the New Yaxley Catalog. FREE. Send for it today.

YAXLEY MFG. CO.
Dept. S-9 S. Clinton St.,
Chicago



ALWAYS UP-TO-DATE

Issued quarterly, March, June, September and December. Single copies U.S. and Canada \$1.00 (Foreign \$1.10). Yearly subscription \$3.25 (Foreign \$3.50).

Amateur and Commercial Stations from 83 different countries.

Radio Amateur Call Book
508 So. Dearborn St., Chicago, Ill., U.S.A.

Calls Heard

(Continued from Page 53)

eh-9xf eh-9xg ei-1zo ei-1zy ei-1dr ei-1fe ei-1op ei-1emm ei-1mm ei-1dc ei-1po ei-1as ei-1ss ei-1xy ei-1mx ei-7dd ei-7ff ei-7oo ei-7ww ek-4vt ek-4af ek-4kg ek-4dk ek-4yaek ek-4uak ek-4ev ek-4hf ek-4br ek-4abg ek-4adi ek-4xy ek-4ia ei-1ala ei-1alg ei-1a2b em-smux em-smuk em-smxr em-smxs em-smxs em-smus em-smxn sm-smute sm-smzy sm-smuq em-pfx em-oga em-odj em-owim em-oxak em-ocx em-ozf em-ogf em-ohi em-ooa em-owx eo-1bb ep-1bv ep-1br ep-1bs ep-1aa ep-1ae ep-1a eo-2aa er-5fr er-5af er-5ll er-5ll es-1eo es-1em es-2dk es-5nl es-3de es-6dmt es-2nd es-1uw es-2nai es-7dj es-2nap es-3da et-tpka et-tpkv et-tpew et-tpzz et-tpim et-tpur et-tp33 et-tpa et-tpam et-tpju et-1e et-2as et-3cx et-3pp et-3xy et-3va eu-1sp eu-2xq eu-2dq eu-2bk eu-2cm eu-2ed eu-2crb eu-2as eu-2bw eu-3kac eu-3am eu-4ah eu-5ay eu-5bc eu-5ar eu-5al eu-6am eu-7kad eu-8aa eu-9ad eu-9ak eu-9am eu-9ac ex-1zf ex-1ww ex-1as zeg-3dm zev-rdq ai-2bj ai-2bl aq-2gq eu-8aa ag-7kad fc-2dd fi-1ta fm-8kr fm-8ax fm-8rit fm-8kl fo-9wa fz-8xz w1ax w1rr w3ajh w3ang sa-3de sb-1ah sb-1ic sb-1ar sb-1bs su-8an z12cb

G. Conte, 24, Allie du Rocher, Clichy sous Bois, Seine et Oise, France

w1ad w1acu w1af w1age w1shw w1aix w1akm w1ara w1awd w1axq w1bg w1bhs w1bke w1bl w1bfl w1bux w1cjh w1ckp w1cmf w1cmx w1enz w1di w1gh w1gw w1ic w1ii w1mo w1mw w1om w1rf w1si w1sk w1xf w2ad w2ac w2af w2ag w2au w2an w2ap w2aq w2ak w2ase w2as w2aq w2au w2av w2aw w2az w2ak w2ab w2bc w2ck w2dh w2bf w2box w2ce w2rb w2cu w2cx w2cl w2dl w2fs w2kx w2md w2ra w2sm w2if w2tp w2ty w2wi w3acm w3af w3ag w3ah w3ai w3ab w3ap w3au w3ev w3ex w3pf w3qe w3sz w3ut w3au w3ad w3ac w3acx w3hx w3jr w3nf w3th w3ob w3q w3tu w3ux w3rg w3ru w3se w3ab w3aly w3axx w3bh w3bx w3bt w3cc w3ce w3cw w3ek w3cn w3cs w3ct w3ed w3eg w3ee w3ec w3edme w3dne w3dod w3dps w3dsa w3es w3ex w3jy w3sh w3vb w3abu w3acs w3ad w3ap w3ara w3ay w3che w3er w3ey w3es w3ds w3ef w3efz w3uz velad velba he2bg sa-de3 sa-dq4 sb-1ah sb-1ak sb-1bg sb-1bl sb-1br sb-1is sb-1ea sb-1ek sb-1dc sb-2ag sb-2az sb-5bf sb-6ja sb-7aa su-2ak.

W3LB, Roger W. Clipp, Hagerstown, Maryland

w1af w1ahr w1bg w1bl w1hj w1ja w2bl w2chk w2gj w2pa w2re w3ac w3ap w3an w3ap w3au w3aw w3bh w3b3 w3bu w3ev w3jy w3jn w3st w3ak w1ll w4gf w4nc w4vt w5ac w5b w5k w5om w5ak w5ax w5cp w5bf w5b w5br w5bp w5br w5bu w5bv w5bn w5cy w5ce w5co w5can w5cz w5dbn w5di w5rm w5xe w5ain w5am w5bw w5fdj.

W4AJY, Arthur F. Hill, 1504 Wilmer Ave., Anniston, Ala.

w6ac w6am w6ay w6uf w6ab w6sk w6ad w6apd w6at w6aye w6az w6be w6bh w6bp w6bk w6bb w6bs w6bz w6cg w6cl w6ch w6cv w6cn w6cjn w6cna w6ctx w6csj w6cu w6ct w6cy w6ddn w6dmg w6dnn w6dpa w6dpo w6dpu w6dyd w6dgn w6dwp w6dyo w6dya w6eao w6au w6abn w6efe w6ehe w6ehi w6eli w7bd w8bo w8bx w7cx w7ey w7dd w7kl w7lp w7ts w7wl w8bh w7ac w7ad w7acu w7ech w7uj w7mx w7ant w7aca fl-1ab k8an nh-lug nj-2pa nm-1g nm-9a nn-7nic nn-cab br-2ea nr-ge nq-2iq nq-2kp nq-5ay nq-5d nq-5vy z1-2aw sc-1ag sc-1aw sc-1ej sc-1dr se-2ah se-2ea se3bm ve3ch ve3cs ve4fv ve4hh ve4gm ve5bk ve5cj.

W8CMB, Edward Nau, 2909 E. 37th St., Cleveland, Ohio.

(30 meters)
w5cm w6bam w7at w7iy.
(40 meters)
w6adg w6awy w6cha w6eca w6drb w6dyi w6uj he-1dp he-lem in-3jn nn-1nic nn-7nic nq-2co nq-5ay nq-5fl nr-2fg oa-2hm oa-3gr oa-5hg oa-7il oa-2zo sb-1aw sb-1ca sb-1ab sb-7ab se-1rx se-2ea ve4fv ya-1fm g6k gky m8 in1 oid oxva rwr scx ajb smia wfab wfat wsq wwet xaf xda xwab.
(20 meters)
w6asi w6sw w6cu w6cz w6dog w6no w6ql et-2x cm-2it ve4fv ve4dk ve4gm ve4hh sb-1cm.

FREE

— A booklet of
Helpful Hints for
Better Transmis-
sion and Reception

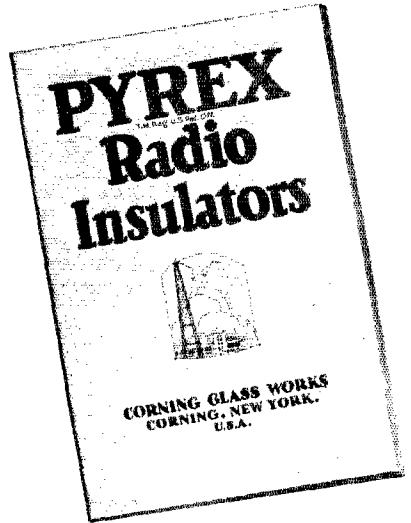

THIS Booklet discusses facts that are important to every Radio Engineer and Amateur, explains why good insulation is essential, and gives data on correct insulators for all types of transmitting apparatus and receiving sets. A copy should be in your file for ready reference.

The PYREX* Insulators illustrated and described are the ones universally recommended for highest electrical resistance, strength in mechanical tension and the chemical stability for everlasting dependability under climatic and destructive exposure.

The PYREX line includes antenna, strain, entering, stand-off, pillar and bus bar types of every desirable size, such as are used by the big broadcasting stations, U. S. Lighthouse, Coast Patrol, Lighthouse and Air Mail Services, Commanders Byrd and MacMillan, and exacting Amateurs everywhere.

*Trade Mark Reg. U. S. Pat. Off.

Get the Booklet

by mailing the coupon and get PYREX Radio Insulators from your nearest supply house or if necessary directly from us.

CORNING GLASS WORKS, Industrial and Laboratory Division,
Corning, N. Y.

Please send the PYREX Radio Insulator booklet.

Name _____
Print name and address

Address _____

QST

FROST-RADIO FROST-RADIO FROST-RADIO FROST-RADIO FROST-

FROST-RADIO MICROPHONES

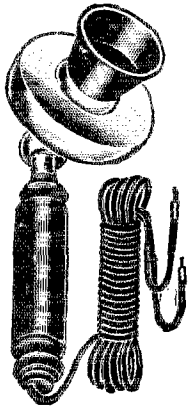

Built of finest quality materials so as to deliver 100% satisfaction for ham use. Solid back, carbon button type. Have unusually sensitive microphones which reproduce all audible frequencies with great fidelity and trueness of tone. Supplied complete with superior quality tinsel cords.

- | | |
|--|--------|
| No. 185 Hand Microphone | \$6.00 |
| No. 159 Desk Microphone | \$8.75 |
| No. 187 Pony Arm Microphone for wall or panel mounting | \$4.50 |

HERBERT H. FROST, INC.,
Elkhart, Indiana

Chicago

San Francisco

Technical Information Service Rules

1. Before writing, consult the Radio Amateur's Handbook and your files of QST. Nine times out of ten the answer will be found.
2. Number the questions and make a separate paragraph of each one. Make the questions as brief as possible.
3. Write on one side of the paper only and use a typewriter if possible.
4. Make diagrams on separate sheets of paper and fasten them to your letter with a pin or paper clip.
5. Print your name and address in full on each sheet of paper. A return address on the envelope is not sufficient, as the envelope is destroyed by the office manager as soon as the letter is opened.
6. Keep an exact copy of your questions and diagrams and mention that you have done so.
7. Do not ask for opinions on, or comparisons of, business concerns or their products.
8. Enclose postage for the reply but do not send an envelope. It is more convenient for us to use our own envelopes with our stationary.
9. Address all questions to the Technical Information Service, American Radio Relay League, Inc., 1711 Park St., Hartford, Conn.

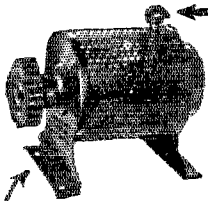

Precision power resistor. Speed control for small motors. Push-button accelerator. Sturdy iron case. Ample heat radiation. Protected terminals. Neat. Handy. Safe.

for Television

Whether you are or are not interested in television, you have real use for this Speed Control Clarostat. It's a wow! Handy, compact, simple, practical. Handles 80 watts without finching. An ideal line-voltage control. A fine heavy-duty resistor of any value from 25 to 500 ohms. And it only represents other members of the Clarostat family.

Write for our dope on Clarostats and how to use them. Or ask your live-wire dealer to show you the Clarostat line.

CLAROSTAT MFG. CO. INC.
Specialists in Radio Aids
283 N. 6th St. Brooklyn, N. Y.

CLAROSTAT
REG. U.S. PAT. OFF.

Strays

Calories vs. Kilocycles

Dick Hilferty, formerly "DH" of W1FL, now of the staff at WHD, and Miss Katharine Finnegan of Minneapolis and Grand Forks, North Dakota, were married in New York City on New Year's Day. As Mrs. Hilferty is a dietician of note, we know that the future "midnight meals" will be well worth participating in.

W5ATZ is enthusiastic about the idea of putting the receiver key and power switch within easy reach of his bed so that the station may be operated from the snoring position. For amateurs who have little time to operate during the day or early evening it permits sleep to be lost in favor of operating with a minimum of discomfort. On these cold nights, when the air is so full of interest, the scheme certainly results in more early morning international work than would be the case if it was necessary to get half dressed and sneak out to the shack.

The formula appearing on the chart on page 27 of the December issue contains the term "V²" which is not included in the tabulation. This should be "p²". It, of course, has no effect whatever upon the accuracy of the chart itself.

This CROSLLEY

AC Electric GEMBOX

\$65.



The 8 tube AC Electric SHOWBOX—\$80

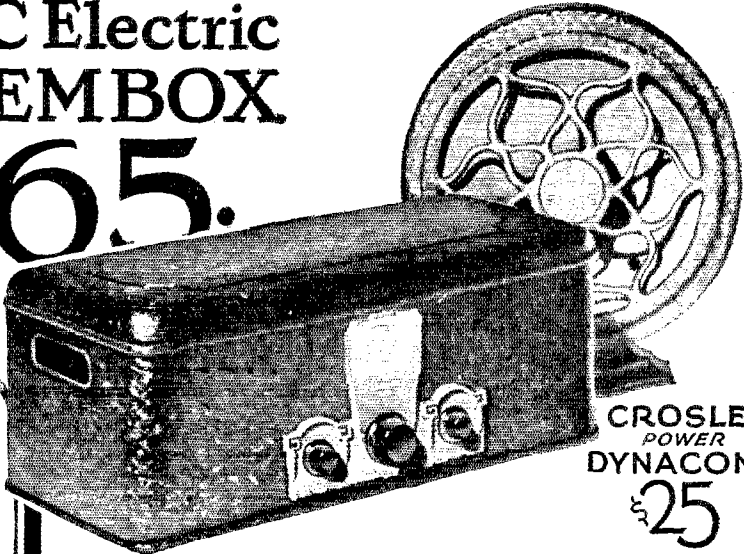

CROSLLEY
POWER
DYNACONE
\$25

Genuine Neutrodyne circuit—push-pull audio amplification with two 171 power tubes on last stage—trouble proof Merphon condenser supplying full 180 volts CONSTANTLY—modern illuminated dial—(7 tubes, radio, detector, audio stages and 1 rectifier, 8 in all)—operating dynamic type power speaker—unbeatable in performance and value offered—\$80.



Crosley Battery Type Sets embody superior advantages of new AC models. The 6 tube **HANDBOX** operates the **DYNACONE**, new Crosley dynamic type speaker. Price \$55. The 5 tube **BANDBOX Jr.** is a dry cell set very easy on batteries and operates loud speaker. Price \$35.



..gives no condenser trouble

The higher the voltage the better the reception. Crosley has designed this set to stand maximum power supplied CONTINUOUSLY. Celebrated Merphon Condensers used in the power supply section do NOT BREAK down. If they should be punctured they are self-healing. Paper condensers constantly break down and the only safeguard is to reduce power which reduces enjoyment of your radio.

..operates power speaker

The popular dynamic quality of radio reception is attained in the new power CROSLLEY DYNACONE. This speaker like its predecessor has created a tremendous demand because of its wonderful performance at so low a price. The range of true notes on this new speaker has been greatly increased over accepted standards.

..uses famous Neutrodyne circuit

This well known and preferred radio circuit is introduced into this inexpensive radio that you may possess the BEST possible apparatus for receiving radio programs. This with other Crosley features permits you a degree of selectivity and sensitivity that many a radio at twice and three times the \$65 price of this set will never have.

..embodies latest radio improvements

Modern illuminated dial for dark corners—is easy to read especially these days of hunting about for station reallocations. The rich gold highlighted brown case is both an attractive container and an efficient shield. Everything about this amazing set is NEW, UP-TO-DATE! Enormous demand—mass production—straight line assembly—enables Crosley to top the radio world with this unmatched value this season!

THE CROSLLEY RADIO CORPORATION

POWEL CROSLLEY, JR., Pres.

Department 18

Cincinnati, Ohio

Prices quoted are without tubes. Montana, Wyoming, Colorado, New Mexico and West, prices slightly higher.

THERE WITH A CROSLLEY

Individual — Independent Speaker Volume Control

The Centralab Constant Impedance Volume Control is the only unit that allows a number of speakers operated from the same amplifier to be controlled individually without affecting the other speakers in the circuit. It is a dual resistance unit with one resistance shunting the speaker for volume control and the other resistance in series with the line.

Adjusting the knob varies both resistances so that while one short circuits the speaker to control volume, the other resistance is added to the line maintaining a constant impedance. Easy to install, smooth and efficient in operation. Send for interesting booklet of picture and wiring diagrams, "Voltage and Volume Controls—Their Use."

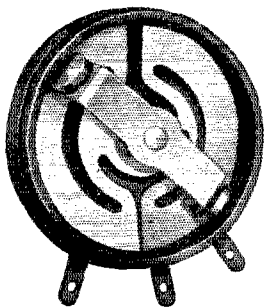

Constant Input Resistance
List Price—\$3.00

Central Radio Laboratories
18 Keefe Avenue
Milwaukee, Wisconsin

Strays

In the October IARU Department, on page 51, we ran a photograph of station ZL2AC, and stated that it was owned by Mr. Sydney Strong. The photo was indeed of ZL2AC, but the station is owned by Mr. Ivan O'Meara, and not by Mr. Strong. We regret that this error occurred.

Experimenters' Section

(Continued from Page 51)

bend so that in case of an accidental turning backwards of the scape wheel, the pin will lift it going in either direction and avoid damage. Adjust the gap to about 0.005 inch.

The pin should engage the V on the wiper at the beginning of the drop and it will

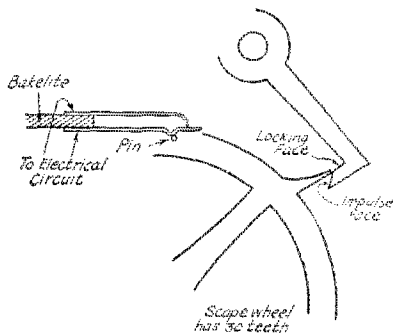

FIGURE 2

then hold contact while the tooth rides on the locking face of the pallet until the pendulum swings to the end of the arc and returns to the point where the tooth unlocks and enters the impulse face of the pallet. This will give a sustained period of about 1/3 second duration which will make a distinctive mark on the graph through some suitable wiring arrangement.

The current through the contacts should be of the order of two or three milliamperes and not more than 1.5 volts should be employed to avoid any welding effect at the contacts.

The reason for using two springs is that the oil on the pivots may sometimes act as an insulator to the weak current and, again, the electrolytic effect is not good for the oil.

Ten years ago, such a contact was put on a gauge here, operating through a sensitive relay to sound an alarm and it is still functioning.

—George N. Engert.

COUPLING TO THE MONITOR

Our old friend Herb Walleze who is getting to be a regular contributor to the "X" Section suggests the method shown in Figure 3 by means of which the phones do

Ad. Auricma, Inc.
Manufacturers' Export Managers
125 Broad Street New York, N.Y.
Scientifically equipped to economically export dependable receiving and transmitting radio apparatus

CLAROSTAT
SANDPAR
ESCO
BRACH
FARRAND
PIERCE
AERO
SPEAKER
GURDINI
PYREX
BEEDER
PUBLIC
BEEDER
BRACH

**164
PAGES
of RADIO
VALUES**

A NEW CATALOG JUST OFF THE PRESS

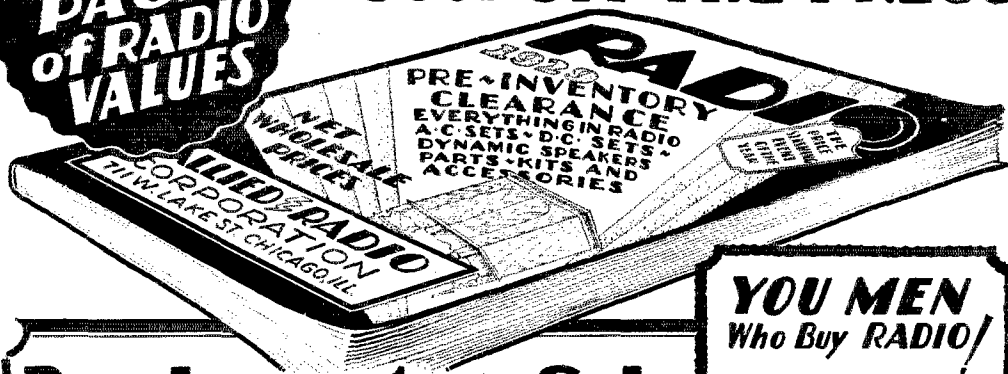

YOU MEN Who Buy RADIO!

By making your problems our problems, we know the service you require—and to render you such service the entire Allied organization is dedicated—to give you the service you have a right to expect. Tremendous stocks, remarkable values and a real desire to serve, all combine to make Allied your ideal source of supply.

Pre-Inventory Sale

A PRE-INVENTORY SALE featuring some of the most drastic price reductions of the season. Our tremendous stocks must be reduced. Prices have been cut to the bone. Everything in our large stocks of radio merchandise is included. You will marvel at the remarkable values. Now is the time to buy. A new large catalog, featuring these remarkable values is now ready. Every radio enthusiast—every dealer—every set builder should send for this new catalog—quoting lowest wholesale prices on everything in radio.

SET BUILDERS!

Set Builders, Amateurs and so called "Hams" will delight in the unusual variety—and remarkable values that are offered in standard kits and parts. Tremendous stocks—real organization—prompt shipping service all combine to make Allied your ideal source of supply.

RADIO DEALERS!

The live radio dealer—the man who keeps pace with the rapid advance of radio will find much of real interest in the Allied Catalog. New A-C Sets, D-C Sets, Dynamic and Magnetic Speakers, television equipment, in fact everything that an impatient radio public is demanding.

LOWEST WHOLESALE PRICES

Allied Service will prove a revelation to you in what radio service can really be. Allied Executives backed by years of training in radio are practical men. They know radio. Their vast experience has built up around them an organization trained to serve. Months of effort have built up here a tremendous reserve of stock that makes for prompt shipments; and this stock is now stock comprising the seasons pick of such prominent manufacturers as Silver-Marshall, Tyrman, Aero, Hammerlund-Roberts, etc.

You Profit When You Buy Right

Buying right is half the battle. From the small set builder to the large dealer, your success depends upon gauging the public pulse of radio and in buying right. Everything that is new in radio—the items the radio public is now demanding are here, ready for your call. Write now—the catalog is free for the asking.

Write for Catalog Now

**Allied Radio
CORPORATION**
711 W. LAKE ST., Dept. P-3 CHICAGO, ILL

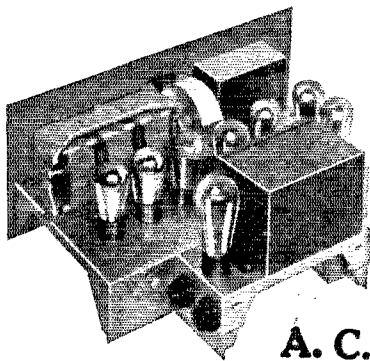

A. C. ELECTRIC SETS

Allied offers you a new—complete line of A-C Receivers, available in either chassis form or in a wide variety of beautiful console models. Prices range from \$22.95 to \$199.00. Dollar for dollar they stand out as one of the season's leading receivers. Engineered to unusual perfection they offer you features found only in the highest priced sets.

BOUND VOLUME XII of QST

WE have now a limited number of copies of Bound Volume XII of QST. Vol. XII comprises the entire 1928 series of QST. This volume is made up of two books or sections, each containing six issues of QST. This volume is handsomely bound in red cloth and with gold imprint.

The complete volume is priced at \$5.00, postpaid.

Better act quickly—only a few copies available.

QST

1711 Park St. Hartford, Ct.

not have to be continually switched from the monitor to the receiver and back again. By connecting the filament of the monitor tube across the six-volt starting relay, the monitor is automatically turned on with the transmitter.

If a high ratio audio transformer is used, this arrangement will not reduce the strength of incoming signals. It does, however, reduce the strength of the signal from the monitor when compared with the method whereby the phones are transferred from

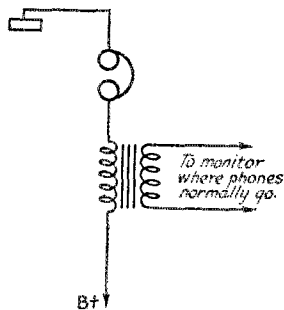

FIGURE 3

the receiver to the monitor although this reduction is not at all damaging. The time and trouble saved in switching over from one to the other more than compensate for any loss in monitor signal.

He also suggests that one of these E210 Bradleystats that may be obtained for about \$1.60 makes a good field rheostat for the small motor-generator and costs about \$15 less than the regular job built for the purpose.

REFLECTORS

Commenting upon the short note concerning reflectors, we received the following from W. G. Wagener, W6BEZ:

"A vertical half-wave antenna will radiate energy equally well in all directions and if a similar antenna is located parallel to it and a half wavelength from it, it will absorb some of this energy and re-radiate it. Because the second antenna is a half wavelength from the first, its induced current will be in phase with the current in the first antenna. This will result in best transmission of the combined energies of the antenna and reflector in a broadside direction as explained in previous articles on directional antennas.

"Consider the case of two wires close together. Let the current in the first one be increasing. The magnetic field will be building up about this wire and cutting, as it does so, the second wire. The induced current in the second wire must be in such a direction, that its magnetic field will oppose that field which is responsible for the induced current. This is the fundamental principle in the generation of any current. Obviously then the two magnetic fields will be 180° out of phase. If these two wires are so close together that the time for the magnetic field to travel from one to the

2000 HOURS OF SUPER TUBE SERVICE

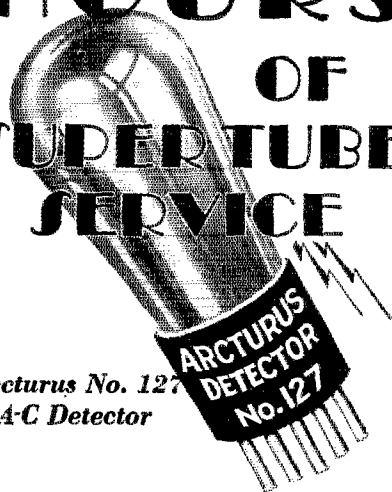

Arcturus No. 127
A-C Detector

ARCTURUS
A-C LONG LIFE TUBES
ARCTURUS RADIO CO., NEWARK, N. J.

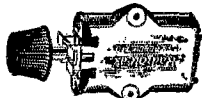

\$4 Bradleystat No. E-210, Special \$1.60

General Radio Type 285



Audio Transformer
Ideal for high and even amplification.
Type 285-H—\$ to 1
Type 285-D—\$3.7 to 1
Type 285-L—\$2 to 1
List \$6.00 **\$2.95**
Now only



\$2 Mesa Telegraph Key ..\$1.45
Signal Buzzer Set International Code on Baseboard\$2.45

Television disks as specified in QST special\$1.95

Acme 500 w. plate transformer, 1000-1500-2000 each side of centre tap, \$24.00
Acme B.H-1 transformer, 225-510 each side of centre tap; also 2 fil. windings of 4 v. each side of centre tap, \$10.25.
Acme C.W. 30 Henry choke, \$18 list—150 M. A. single \$14.40; also other sizes at special prices.

LEEDS

The Home of RADIO
45 VESEY STREET
NEW YORK

New York's Headquarters for Transmitting Apparatus

When in Town Visit Our Store

Full Line of Acme -- Thordarson -- Jewell -- Flechtheim -- General Radio -- Signal -- Bradley

SPECIALS

- Beiden braid 1/4" wide; ideal for shielded grid tubes, ft. .06
- Marked ERY binding posts; reg. 15c special each .05
- Pacet DeLux No. 124 Phonovox—The electrical pick-up; List \$13.50. Special 7.50
- General Radio 217D .001 cond. plain or with varner 1.75
- \$15. Imported German head sets; very sensitive 3.45
- Honeycomb Coils unmounted, all sizes in stock 1/2 price.
- \$8 Signal Corps adjustable arm micro-transmitter for panel mounting 2.45
- \$9 Duplicator condenser, 4mf; 600 v. D. C. working type 999; limited quantity 2.45
- \$5.50 Duplicator Cond. 2mf; 600 v. D. C. 1.45
- R. E. L. Transmitting Inductances, per set 8.80
- Bristol 50 Henry choke 2.75

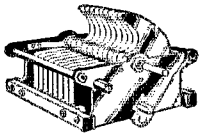

Cardwell condensers, double spaced for transmitting, .00025 cap. 3.45

Everything in Cardwell In Stock

- No. 12 Enameled copper wire, any length, ft. \$0.1
- No. 10 Enameled copper wire, any length, ft. .01 1/2
- Genuine Bakelite Panel 10x14x1/4 1.50
- Baldwin phones type C pair 5.95
- Myers \$5 4 1/2 volt Det. or Amp tube, complete with mounting clips .95

Pyrex Low-loss V.T. sockets, each 39c.

R. C. A. socket; porcelain base, metal top 50c

General Radio 3 By Pass Condenser



\$1. List. Tested at 500 v. D.C. Ideal for Filament By Pass **30c.**



Ward Leonard Resistance
\$4.75 list—6 1/2 inch long—800-1000 - 1200 - 3000 - 6000 - 8000-11000 ohms; can be used

ACME POTENTIOMETER RHEOSTAT

A combined Pot. and filament Rheo.
6 ohm rheo-100 ohm pot.
30 ohm rheo-100 ohm pot.
30 ohm rheo-300 ohm pot.
TWIN RHEO for low voltage tubes. List \$3.00. Special each 65c



ACME VARIABLE RATIO A. F. TRANSFORMER

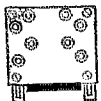

Recommended for short wave C.W. reception exclusively. Has sharp peak—gives excellent results. List price, \$7.00 each. Special **\$2.75**

NEON GLOW LAMPS

Made by General Electric Co., type G. 10, standard base, 101 uses, as illustrated in QST May issue page 17 Price only65c

RADIO FOUNDATION TRANSFORMER



Will carry 6 or 7 -227 A.C. tubes tapped at 2 1/2-3-3 1/2 volts. List \$6.00. Special \$2.25

ACME TRANSFORMER

Listed at \$5.00. The universal transformer for Super Het. 30 K. C. Limited quantity at \$1.10

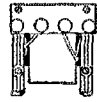

General Radio—200 watt Full Wave TRANSFORMER

Type 565-B. Secondary voltages 1200 volts (with centre tap) 7.5 v. 7.5 v. Maximum current 200 MA. 2.5 Amp. 2.5 Amp. Price

\$13.50

WIRT Cone Speaker DRUM \$8.50 TYPE Reg. \$25



French Hand MICROPHONE

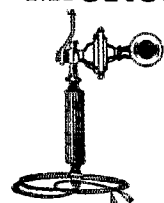

Listed at \$10
Nickel Silver Finish
Vulcanized rubber handle.
A wonderful buy **\$6.25** at . . .

VARIABLE FILAMENT TRANSFORMER

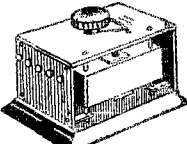

125 watt—110 volt—60c. Tapped at 4-7-10-13-17-20-24-30 volts. Limited quantity List \$19. Special \$4.45

Flechtheim Condensers all types 35% off list.

General Radio No. 358 Short Wave Meter, 14 to 25 meters. List \$22, special \$15.00



We carry the largest stock of GENERAL RADIO PARTS in the country

Two inch space wound Hamm. inductance No. 16 d. s. c. green. Special price per inch **35c**

MAIL ORDERS FILLED SAME DAY 10% Must Accompany All Orders

PLEASE PRINT YOUR NAME AND ADDRESS PLAINLY to AVOID DELAY



For Power Amplification Select from Successful Parts of the 1928-'29 Season

FOR USE WITH UX 250 TUBES

- No. 7568—Transformer for full wave rectification using 2 UX 231 tubes to supply B and C power to receiver and power for 2 UX 250 tubes \$13.50
- No. 8529—Transformer similar to No. 7568 with the addition of 2 low voltage windings, one for 226 tubes and the other for 227 tubes so that you can build a power amplifier for either radio receiver or phonograph pick-up. \$16.50
- No. 6551—Double Choke, for use with above transformers. \$15.00
- D-600—Power Amplifier Condenser Unit . \$16.50
- D-307—A Condenser Block, used in connection with D-600. \$10.00
- No. 1177—Straight Power Amplifier Output Transformer. \$12.00
- No. 1176—Same as No. 1177 but of Push Pull type. \$12.00

CUSTOM SET BUILDERS

Your trade will get the best from sets built up with these parts. Discounts quoted on request.

Dongan Electric Manufacturing Co.

2999-3001 Franklin St., Detroit, Mich.

TRANSFORMERS of MERIT for FIFTEEN YEARS

other is negligible, the current induced must be 180° out of phase with the original.

"If these two wires are the two half-wave antennas and the first is carrying a rapidly alternating current and they are spaced such a distance apart that the time for the magnetic field to travel from one

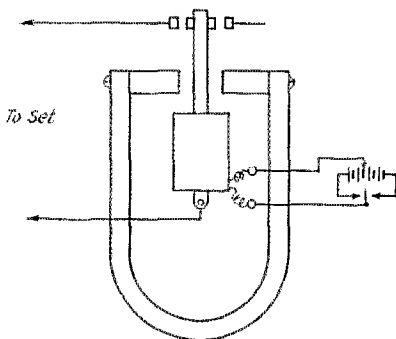

FIGURE 1

to the other, which it does with the speed of light, is the time required for one half a cycle, we have the original set-up of two antennas at a half wavelength apart. Hence the magnetic field which has arrived at the second antenna or reflector lags by half a cycle or 180° the magnetic field which is just leaving the first antenna. Adding this 180° lag to the 180° change when a current is induced in the reflector, we have 360° or one complete cycle which means that the currents in antenna and reflector are in phase.

"We see that whenever a magnetic field cuts a wire and induces a current in it, a change of phase of one half cycle or 180° must be allowed for.

"Consider now the reflector wire placed one quarter wavelength behind an antenna. For the magnetic field to travel from the antenna to the reflector requires one quarter cycle or 90°; for a current to be induced and re-radiate a magnetic field requires a half cycle or 180° change of phase and for this re-radiated field to return to the antenna requires an additional quarter cycle or 90°. Hence the total elapsed effective time is one whole cycle or 360°. Thus the two fields will be in phase and their energies will add to give increased radiation in the direction along a line from reflector to antenna. In the direction from antenna to reflector we found the two magnetic fields to be always 180° out of phase. This latter fact will be true no matter how far away from the antenna the reflector is placed, and so a resonant wire anywhere will always weaken the field behind it.

"From the preceding paragraph it is obvious that in a parabolic reflector, the distance from the antenna back to the nearest reflector wire must be a quarter wavelength. The parabola will then be built with this as the focal distance. Hence in

CODE LESSONS FREE

With the **TELEPLEX**
CODE INSTRUCTOR

With each Teleplex Code Instructor we furnish complete code instructions for beginners or advanced students. Code lessons recorded on strong, waxed-tape records make everything simple and clear. When you own a Teleplex it's like having an expert operator in your home. Sends messages, radiograms, etc.—regular code traffic same as an operator would. Endorsed by U.S. Navy and leading schools. Thoroughly tested and guaranteed.



Write for descriptive literature, prices, etc.

Silent
Phonograph
Motor

TELEPLEX CO., Dept. RL., 76 Cortlandt St., New York, N. Y.

More Profits To Set Builders

Elections, football games big National event will boost radio business this year. Set build now will reap a rich harvest. Barawik service will make you money. Everything in A-C sets, short wave, television, parts, supplies. World's largest radio stocks on hand. Orders shipped same day. Lowest stock bottom wholesale prices.

Write for Free Radio Catalog

BARAWIK CO 112 Canal St., CHICAGO, U. S. A.



VITROHM Transmitting Grid Leaks and Rheostats now cover the entire line of transmitting tube circuits. ¶The prices on these amateur products are reduced materially. ¶Your dealer should stock Vitrohm Transmitting Products. ¶If you have difficulty in obtaining them, write us direct.

CATALOGUE NUMBER	PRODUCT	RESISTANCE	DISSIPATION	CURRENT	MAX. TUBE RATING	PRICE
507-2	Grid Leak*	5000 ohms	44 watts	90 m.a.	100 watts	\$2.00
507-3	Grid Leak*	5000 ohms	200 watts	200 m.a.	1000 watts	2.80
507-4	Grid Leak†	50,000 ohms	200 watts	60 m.a.	1000 watts	6.50
507-5	Grid Leak†	20,000 ohms	200 watts	100 m.a.	1000 watts	4.25
507-51	Grid Leak*	10,000 ohms	200 watts	135 m.a.	1000 watts	4.00
507-66	Grid Leak**	15,000 ohms	200 watts	120 m.a.	1000 watts	6.00
507-63	Rheostat†*	50 ohms	50 watts	1 amp.		5.50
507-59	Rheostat*†	20 ohms	80 watts	2 amp.		5.50
507-83	Rheostat*†	12.5 ohms	60 watts	2.2 amp.		5.50

* Center-tapped

† DeForest P or R. C. A. 852 Tube
De Forest H Tube

** Steps at 5M—10M—15M

for R. C. A. 852 or DeForest P Tube

†* For Primary Control

*† Filament and Primary Control

Ward Leonard Electric Company

37-41 South Street

Mount Vernon, N. Y.

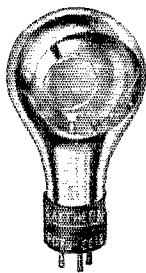

Raytheon

This name represents leadership in tubes for television broadcasting and reception.



Foto-Cell

A Television sending tube in hard vacuum or gas-filled types.

Correspondence is invited from amateurs in regard to Raytheon Television Products.

RAYTHEON MFG. CO.
Kendall Square Building
Cambridge, Mass.

Kino-Lamp

The Television receiving tube adapted to all systems. Price \$7.50.

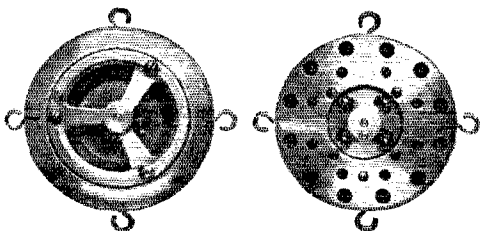

We invite inquiries from manufacturers, jobbers, dealers, etc., on our IMPROVED 2 button stretched diaphragm microphone. At \$67.50 we firmly believe this to be the finest value in high-grade microphones for Broadcast, Public Address, Photograph Recording, and other exacting uses. Ask for data on our broadcast inductances, and high-voltage fixed and variable air condensers.

E. F. JOHNSON COMPANY, Waseca, Minn.

?

HAVEN'T YOU
SUBSCRIBED TO
RADIO ENGINEERING
YET?

(See page one, January QST)

RADIO ENGINEERING
52 Vanderbilt Ave., N. Y. Cy.

AEROVOX

BUILT BETTER
CONDENSERS AND RESISTORS

How Do You Buy Condensers?

Most filter condenser blocks are bought merely on the basis of price and their voltage ratings.

In view of the many overrated condensers now on the market, the only dependable indicator to use in buying condensers is their insulation specifications and the care with which they are tested.

The Aerovox Wireless Corporation makes no secret of the insulation specifications of their filter condensers and filter condenser blocks. This information is contained in detail in the 1928-1929 catalog.

The next time you buy filter condensers or blocks make your comparisons on the basis of insulation specifications, voltage rating and price. On that basis Aerovox Filter Condensers and Blocks will undoubtedly be your choice.



This is a monthly publication which will keep you abreast of the latest developments in radio. Free on request.

AEROVOX WIRELESS CORP.
78 1/2 Washington St., Bklyn., N. Y.
PRODUCTS THAT ENDURE

Neutralization Means— More Power From Any Set

Science has proven that neutralization is the only satisfactory method of controlling oscillation in a Tuned Radio Frequency Circuit and that it increases the actual power per stage of amplification 25 to 300%.

The Neutrodyne principle can be applied to practically every set by the simple installation of X-L Vario-densers. The result is an amazing increase in the efficiency and power of the receiver. Send for interesting book of circuits and picture diagrams showing the use of the Vario-denser.

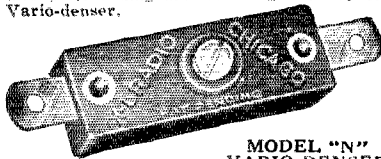

MODEL "N"
VARIO-DENSER

Has variable capacity, adjustable from 1.8 to 20 micro-microfarads, which is .0000018 to .00002 microfarads. Price each \$1.00.

X-L RADIO LABORATORIES
Dept. D 1224 Belmont Avenue, Chicago, Ill.

NATIONAL VELVET-B

A new 180 volt B Supply of first quality at the low price of \$26.50. (less tube)

Write for bulletin Q-132

NATIONAL CO. INC.
MALDEN, MASS.

Figure 5 on page 49 of the December issue, the distances should be $\lambda/4$ and $\lambda/2$.

"From the above considerations of phase changes in induced currents and the addition of wave motions of varying phase relations, any reflector system can be designed and analysed."

POLARIZED RELAYS

1032 St. Viateur Avenue
Outremont, Que.

Editor, QST:

Speaking of relays that will stay in either the make or break position without a continuous current flowing to hold the armature, a simple form of polarized relay can be made from parts available to all of us and at the same time fill the bill admirably.

A horseshoe magnet similar to those found on telephone magnetos is arranged as shown in Figure 4 with an electromagnet pivoted between the poles. The contact screws are set so as to just prevent the armature from freezing to the permanent

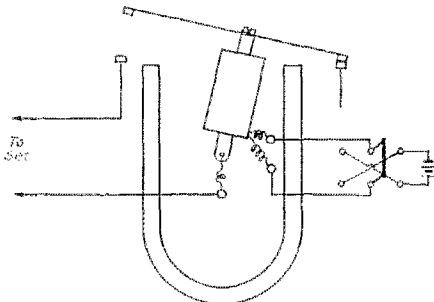

FIGURE 5

magnet poles while still allowing enough attraction to provide good contact. The battery for the electromagnet is wired through a d.p.d.t. switch so that the polarities may be applied as desired. In one position the armature will fly over to one contact and stay there until the reverse polarity is applied when it will click back to the first position again. The battery need only be applied for an instant—long enough to let the armature go to the contact wanted.

A somewhat different mechanical construction for the relay is shown in Figure 5. It will also be noticed that the battery arrangement is not the same. This system operates with a single-pole double-throw switch. The smaller magnetic gap makes this type somewhat more efficient than that shown in Figure 4.

—J. H. Hewson, VE2BX-VE3XM.
—H. P. W.

A Multi-Range Voltmeter

(Continued from Page 50)

8 Eby binding posts 1.20
1 box 7" by 6.5" by 2.25" of 3/8-inch mahogany .80

Synchronous Motors for Television

In addition to building reliable and satisfactory motor generators, "Esco" has had many years of experience in building *electric motors* for a great variety of applications.

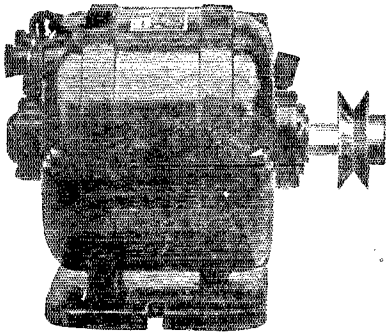

Synchronous motors, small, compact, reliable self starting are now offered for *Television* equipment. They require no direct current for excitation, are quiet running and fully guaranteed.

Other types of motors suitable for Television may also be supplied.

Write us about your requirements.

ELECTRIC SPECIALTY CO.

25 South St.

Trade "ESCO" Mark

Stamford, Conn.

LEARN
Electricity
In 12 weeks by actual work, not correspondence —not books. Earn while you learn. Radio and Auto Courses included. You don't need advanced education or experience. *Send AT ONCE for Bro. Aveo, FREE BOOK!*
COYNE ELECTRICAL SCHOOL, Dept. 29-3B
500 South Paulina Street Chicago, Illinois

QUARTZ CRYSTALS

1750 kc band	\$12.50
2500 kc band	12.50
3000 kc band	20.00

Crystals ground to your specified frequency in any of 1929 bands. Accurate to within 1/10 of 1% Guaranteed A1 oscillators.

MORTON B. KAHN

Radio W2KR

617 West 141 Street New York, N. Y.

RADIO IN BRASIL

When in Brasil, apply to M. BARROS & CIA for anything you need in connection with radio.

M. BARROS & CIA

70 sob. Rua S. José 70 sob.
Postal Box 89

Rio de Janeiro

Telegraph address, Radioparte, Rio de Janeiro
Branch: Avenida S. João 4, S. Paulo, Brasil

Send For WESTERN RADIO *New* 1929 Catalog

Dealers and Set Builders

THE NEW 1929 Catalog is crammed full of the FINEST, NEWEST, Nationally known A.C. sets, consoles, cabinets, dynamic speakers, kits, PARTS, eliminators and accessories at LOWEST PRICES. Largest stock of radio parts. Prompt delivery.

Write for our FREE catalog
WESTERN RADIO MFG. CO.,
128 W. Lake St., Dept. 02, Chicago



"The Big Friendly Radio House"

Potter Condensers

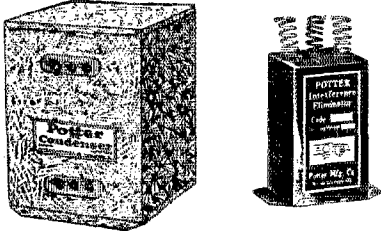

- T-2900** Condenser Block for the single 250 type tube amplifier **\$20.00**
- T-2950** Condenser for the push-pull 250 type tube amplifier . . . **\$22.50**
- T-2098** Condenser Block for single 210 type tube amplifier . . . **\$20.00**
- T-280-171** Condenser Block for power pack with 250 type tube rectifier . . . **\$18.00**
- 105-05** Interference Eliminator for oil burner and icemachine motors **\$3.75**

The Potter Co.
 North Chicago, Illinois
 A National Organization at Your Service

RADIO OPERATORS WANTED

THE EASTERN RADIO INSTITUTE can train you quickly and thoroughly because:

- MODERN AND EFFICIENT METHODS
- THOROUGH INSTRUCTION under staff of LICENSED COMMERCIAL OPERATORS
- MODERN APPARATUS including SHORT WAVE TRANSMITTER
- SIXTEEN years a RADIO SCHOOL
- THE OLDEST, LARGEST and MOST SUCCESSFUL school in New England. RECOMMENDED BY THE A. R. R. L.

Day or Evening Classes Start Every Monday
SPECIAL CODE CLASSES

Write for Illustrated Prospectus

EASTERN RADIO INSTITUTE
 899 BOYLSTON STREET BOSTON, MASS.

QUARTZ OSCILLATING CRYSTALS

Scientifically Prepared for Maximum Power and Unconditionally Guaranteed 1% in sections, within 1% of your specified frequency, supplied at the following prices:

75-100 meters	\$15.00
100-200 meters	10.00
200-500 meters	15.00
1 in. Toler. blanks, 2 to 4 mm thick	5.00

Sections of any practicable dimensions made to order
 Prompt Delivery

J. T. Rooney, B. Sc., 4 Calumet Bldg., Buffalo, New York
 "Ten years' crystallographic experience"

SET Builders

Barawik, the first and oldest radio specialty house, offers you unusual service this year. Bigger stocks, quicker shipments, lower prices. Deal with an old established, reliable house. Get honest goods, honest service, honest prices. Barawik service makes you more money. Send now for big new catalog showing lowest wholesale prices on sets, parts, short waves, etc.

BARAWIK CO. 1122 CANAL ST., CHICAGO, U. S. A.



8 pr. grid leak clips		.80
1 Super-Davohm	1,000 ohms	1.50
1 " "	10,000 "	1.50
3 " "	100,000 "	6.00
1 " "	200,000 "	2.50
2 " "	250,000 "	5.00
		<hr/>
		\$35.50

The fact that this meter require but 1.5 mils for full scale deflection is an important factor; the usual high-voltage meter requires between fifteen and twenty milliamperes for full scale deflection. An additional point that should appeal to the amateur

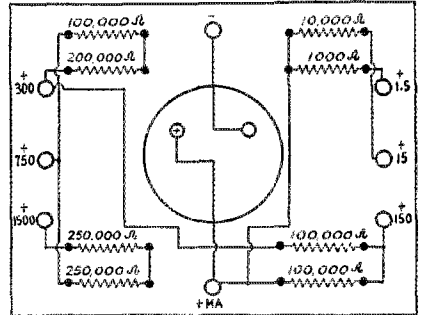

FIGURE 2

who is usually unable to lay any large sum of money at one time is the possibility of buying the parts for such an instrument piecemeal. In this way, it is possible to acquire a worthwhile unit on what is commonly called the "budget plan". Perhaps some salesman will figure out how few cents a day it costs!

A "1929" Receiver

(Continued from Page 32)

any other adjustments to the set, thus protecting the tubes. It also protects the operator against unpleasant "bumps" from

Frequency Range
 in kc.

Coil	Tuning			Max.	Min.
	Secondary	Tickler	Condenser		
No. 1	2 turns	3 turns	5 plates	30,000	27,770
No. 2	8 "	5 "	3 "	14,635	13,955
No. 3	19 "	6 "	2 "	7,370	6,495
No. 4	53 "	7 1/2 "	7 "	4,286	3,333
No. 5	8 "	4 "	23 "	14,285	8,820
No. 6	13 "	6 "	13 "	9,835	6,395
No. 7	20 "	7 "	23 "	7,060	4,286

COIL AND CONDENSER COMBINATION

the plus 135 volts on the screen-grid tubes. Another precaution, which may be applied to any receiver, is the insertion of a small flashlight bulb outside the set in the jumper which connects the "A" and "B" negative leads together. If any point on any of the "B" battery circuit comes in contact

The A.R.R.L. Diamond Is the Emblem of a Real Amateur!



The League Emblem comes in four different forms. Its use by Members is endorsed and encouraged by the League. Every Member should be proud to display the insignia of his organization in every possible way.

THE PERSONAL EMBLEM. A handsome creation in extra-heavy rolled gold and black enamel, $\frac{1}{2}$ " high, supplied in lapel button or pin-back style. There are still a few fellows who are hiding their light under a bushel. Wear your emblem, OM, and take your proper place in the radio fraternity. Either style emblem, \$1.00, postpaid.

THE AUTOMOBILE EMBLEM. Introduced last spring, already more than 800 cars are proudly displaying the mark of the "Radio Rolls-Royce." $5 \times 2\frac{1}{4}$ ", heavily enameled in gold and black on sheet metal, holes top and bottom, 50c each, postpaid.

THE EMBLEM CUT. A mounted printing electrotype, the same size as the lapel button, for use by Members in any type of printed matter, letterheads, cards, etc. \$1.00 each, postpaid.

THE "JUMBO" EMBLEM. You've taken care of yourself, your car and your printing. How about the shack wall or that 100-footer? Think of the attention this big gold-and-black enamel metal emblem will get! $19 \times 8\frac{1}{4}$ ", same style as Automobile Emblem. \$1.25 each, postpaid.

Mail your order and remittance NOW to

The American Radio Relay League : : Hartford, Conn.

NEW RELAYS

for amateurs and experimenters. We would be pleased to hear from you concerning your relay requirements.

If interested in television, write for our price list of television apparatus

Photo Electric Devices, Inc.
594 Fifth Avenue Brooklyn, N. Y.

BECOME A RADIO OPERATOR

See the World. Earn a Good Income.
Duties Light and Fascinating.

LEARN IN THE SECOND PORT U.S.A.

Radio Inspector located here. New Orleans supplies operators for the various Gulf ports. Most logical location in the U.S.A. to come to for training.

Nearly 100% of radio operators graduating on the Gulf during the past six years trained by Mr. Clemmons, Supervisor of Instruction.

All graduates placed to date. Start training now for Spring and Summer terms.

Member of the A.R.R.L.—Call "W5GR"
Day and Night Classes—Enroll anytime—Write for circular.

GULF RADIO SCHOOL
844 Howard Ave. New Orleans, La.

— LAST MINUTE SPECIALS —

R. C. A. Uni-Rectron Power Amplifiers—Model A. P. 935	List \$88.50 ea.	Our Price	\$19.75 ea.
E210 BRADLEYSTATS, list \$4.00 fine for A. C. Line Voltage Control	"	1.60 "
Genuine Black Bakelite Panels $\frac{3}{8}$ " x 48", $\frac{3}{16}$ " thick. Reg. Price \$29	"	8.75 "
U. S. ARMY Aeroplane Spark Transmitters, Gov. cost \$47 each	"	4.75 "
G.E. Kenotron Rectifying Tubes (Type T.B.1.)	"	1.25 "
Gould Kathatron Unipower, Automatic Radio "A" Power (6 volt), list \$39.50	"	13.75 "
G. E. V.T.14—5 watt Transmitting Tubes (A good power amplifying tube)	"	1.50 "

AMERICAN SALES CO., 19-21 WARREN ST., NEW YORK CITY

PLATE GLASS FOR TRANSMITTING PANELS

Better insulation and as cheap as rubber panels. All meter holes and screw holes bored to requirements. Frosted on one side and call letters etched on face. Send sketch of panel for estimate and further information.

PEERLESS PRODUCTS CO.

106 No. 9th St. Radio W9FUE, Hiawatha, Kansas.

BEAUTIFUL! AMAZING!! WONDERFUL!!!

THESE ARE SOME of the enthusiastic comments made by people who know and understand Short Wave Apparatus:

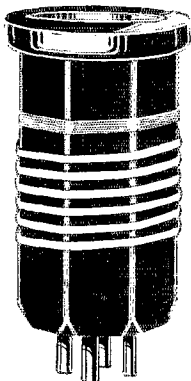

OCTOCOILS

Have become famous overnight. Eight sided Bachelite molded forms in distinctive colors.

Space wound with Nos. 12-14-16 Bare Copper Wire

3 3/4" high 1 3/4" diameter.

Rugged — Beautiful — Efficient. Wave length range.

16 meters to 225 meters

List price \$4.00 Per set of four coils.

Manufacturers also of the BAIRD SW-Adapter: with special features used by no other manufacturer: Absolutely no AC-Hum interference:

If your dealer cannot supply you order direct: Money refunded without question if unsatisfied.

Mfd. by

SHORTWAVE & TELEVISION LABORATORY INC.

104-106 Brookline Avenue, Dept. K, Boston, Mass.

RADIO OPERATORS

Are You Handicapped by a weak Amr or other weakness?

95 out of every 100 operators are handicapped by some weakness. Are you one of them? Would you place yourself in the hands of an expert who has developed many of the world's fastest and highest paid operators, and follow his easy instructions if you thought his methods would help you to overcome your weakness? If you knew positively that his system would increase your sending and receiving speed 50 to 100% and make you a TOP-NOTCH operator? Don't delay. Write me in confidence. No obligation. Write NOW!

WALTER H. CANDLER, Originator and Director
THE CANDLER SYSTEM CO.

6343 S. Kedzie Avenue Chicago, Illinois

FREE 1929 WHOLESALE RADIO CATALOG

Dealers — Set-Builders — Write today for this 1929 Wholesale Catalog containing hundreds of money-saving "specials". Over 2,000 items. Complete lines of Radio Sets, Cabinets, Tubes, A & B Eliminators, Speakers, Parts at prices that mean BIG SAVINGS!

Complete Television Section

Latest television equipment, A. C. Sets, Short Wave Receivers, Dynamic Speakers also listed. Write Now—Dept. 36

BENSON-ALLEN, Inc., 436 So. State St. CHICAGO, ILL.

SCORES OF MONEY SAVING BARGAINS



with the ungrounded side of the filament circuit, the flashlight lamp will blow for "about twenty cents worth," instead of four nice tubes for "ten or fifteen dollars worth."

In concluding it may be said that, although the receiver has so far been given only a brief test, it promises to live up to the reputation set by Mr. Hull's original model.

The UV-861

(Continued from Page 33)

The direct interelectrode capacities measured according to I.R.E. definition are:

Plate to control-grid (filament and screen together)	0.05- μ fd.
Control grid to filament and screen	17. μ fd.
Plate and filament to screen	13. μ fd.

To the man who is desirous of employing all the power the law will allow and

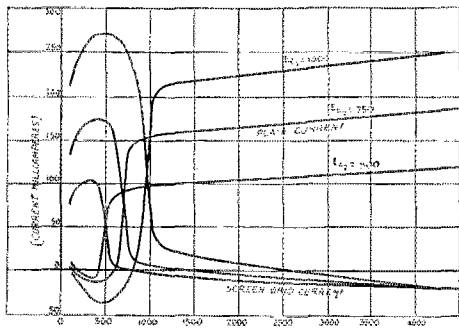

FIG. 5. THIS FAMILY OF CURVES SHOWS THE EFFECT UPON PLATE AND SCREEN CURRENT OF VARIATIONS IN PLATE POTENTIAL.

They show the characteristic dynamatron kinks where the plate voltage is lower than the screen voltage.

who is using crystal control or some other form of oscillator-amplifier arrangement, this tube should prove a boon. The main requirement will be for a husky power supply from which to run it!

An Examination of A. C. Plate Supply

(Continued from Page 27)

condition of precise adjustment. The advent of the new mercury vapor rectifier tubes, of course, has introduced an important factor into the case. By avoiding the particular difficulties of adjusting the self-rectified to the standard of performance required at present, the installation of such rectifiers may be the more practical solution to the plate supply problem at all times. In the past, self rectification for the higher voltage tubes was justified by the scarcity and high cost of suitable rectifiers. We sincerely hope that we are correct when we say that this condition no longer exists.

A. R. R. L. Members -- What about your friends?

You must have a friend or two who ought to be members of our A.R.R.L., but aren't. Will you give us their names, so that we may write to them and tell them about the League and bring them in with the rest of us? The A.R.R.L. needs every eligible radio enthusiast within its ranks, and you will be doing your part to help bring this about by recommending some friends to us. Many thanks.

American Radio Relay League,
Hartford, Conn.

.....1929

I wish to propose

Mr. of

Mr. of

Street & No. Place State

for membership in the A.R.R.L. I believe they would make good members. Please send then a sample copy of *QST*.

.....
.....

TRANSFORMERS

Guaranteed—Mounted—Complete

250 watt 550—700 each side.....\$10.50
700 watt 1000—1500 each side..... 14.50
600 watt 2000—2500 each side..... 18.00

Chokes, Polyphase and 25-cycle Transformers
Add \$2.00 for fl. winding

GES F. GREBEN

1927 So. Peoria Street, Pilsen Sta., Chicago, Ill.

WANTED 50 Watt Tubes

R. C. A. or W. E. Co.

New Used or Burned out

**J. T. SCOTT, 908 Western Ave.,
SEATTLE, WASHINGTON**

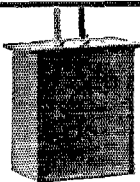

Designed to
carry 250 mills

2 HENRY FILTER REACTORS

D. C. Resist-
ance 20 ohms

Fine for use as Generator Filter, also as
plate or Grid Reactor

Special \$4.75 ea.

Manufactured by the world's largest electrical concern whose name we cannot mention

List Price
\$25.00 ea.

AMERICAN SALES CO., 19-21 Warren St., N. Y. CITY

QST OSCILLATING CRYSTALS

Amateur Bands

We will grind for you crystals in the various amateur bands. Said crystals to be suitable for power use and frequencies stated accurate to better than a tenth of 1% at the following prices:

1715 to 2000 Kcs	\$20.00
3500 to 4000 Kcs	\$27.50
7000 to 7300 Kcs	\$45.00

Add \$10.00 to the above prices if crystal is to be mounted in dustproof power type of holder. Immediate deliveries. All crystals guaranteed regards to frequency and output.

HIGH FREQUENCY AND BROADCAST BANDS

We will grind for you a crystal between 500 and 1500 Kcs to a guaranteed accuracy of plus or minus 500 cycles of your assigned frequency for \$45.00 unmounted or \$55.00 mounted. Three day delivery and crystals guaranteed.

We will grind a crystal for you to your assigned frequency between 4000 and 8000 Kilo-cycles accurate to plus or minus five hundredths of 1% (.05%) for power use for \$75.00 unmounted or \$85.00 mounted in power holder. These crystals absolutely guaranteed regards to frequency and output. Five day delivery.

SCIENTIFIC RADIO SERVICE

"The Crystal Specialists"

P. O. Box 86, Dept. B., Mount Rainier, Maryland.

Complete Parts for SILVER-MARSHALL No. 730

"Round-the-World" 4

A COMPLETE short wave receiver (17.4 to 204 meters) and two-stage audio amplifier. All wave lengths are covered with no dead spots. Amateur bands fall well to center of tuning dial. Net \$30.00. Completely constructed \$38.80. C.O.D. or cash with order. Postage or express extra.

Also Complete Stock of

Leach Relays—R.E.L. Products—3000-Volt Rectobulbs—Omnigraphs—Vibroplexes—Silver-Marshall Shield Grids.

Send for New 1929 Ham Book—FREE

C H I - R A D
**CHICAGO RADIO
APPARATUS CO.**
415 S. DEARBORN ST., CHICAGO

DODGE RADIO SHORTKUT

KILLS HESITATION PRODUCES RESULTS

Has helped raise receiving speed from 15 to 25 in three and half hours—15 to 30 in five hours—10 to 15 in one hour—4 to 12 in four hours etc. etc. Beginners master code and qualify in few days.

REPORTS FROM 500 USERS

telling complete story and who's who with each order. Or with Half Dollar Coupon for 50 cents. Specimen reports on request—sufficient to justify this ad.

DODGE HIGH SPEED METHOD (Intensive Speed Practice)

Most efficient Code Reading booster known for 25 per Ham. Helped raise speed from 27 to 29 in 75 minutes practice time. Full details in reports.

DODGE MORSE SHORTKUT

Master both codes our way and use without mixup. Radio Shortcut \$3.50 High Speed or Morse \$2.50 Money Order. None C.O.D. Foreign add Fifty Cents.
C. K. Dodge, Box 100, Mamaroneck, New York.

PACENT DUO-LATERAL COILS

FOR laboratories, experimenters, engineers and for special circuits, Pacent Duo-Lateral Coils are the accepted standard.

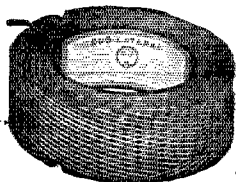

A complete line of all standard turn ratios are always in stock.

Write for information and prices

Pacent Electric Co., Inc.
91 Seventh Avenue, New York

The Design of Inductance Coils

(Continued from page 40)

coil Y, the curve B showed a uniform and normal increase extending from 2 to 5 ohms, which is within 2 percent of the resistance for the coil A when free. Between 300 and 450 kc., tuning would have been impossible with the resonant coil inductively or conductively coupled to the tuned circuit. Obviously, shorting the unused coil when it is not required in the circuit minimized such undesirable reactions. As the coil resistance reaches such enormous effective values, useful currents will not only be small, but will also produce a region in the frequency range where it is practically impossible to tune sharply. Well designed receivers have provisions made to overcome these effects, but available data show they do occur in similar radio frequency circuits. Hence, unused portions of the coil, if large, should be shorted, or windings may be divided into sections and provided with the familiar "dead end" switches. Of equal importance, perhaps, is the selection of coil types having a minimum of capacity. Of course there are cases where limited space requires a compactly wound coil of large inductance having inherently large distributed capacity. Such experiments demonstrate simple cases in which coil capacity is effective. To select good coils of minimum capacity is difficult, for many types of winding developed do not provide low distributed capacity although they may afford a very slight reduction of dielectric hysteresis effects due to the peculiar manner in which the wires are wound. We will next consider types of winding and observe by theory and experiment, the characteristics of most well known types.

(This article by Mr. Clemens is in two parts. The second part, which treats various types of windings and their characteristics, will be published in next QST.—Editor.)

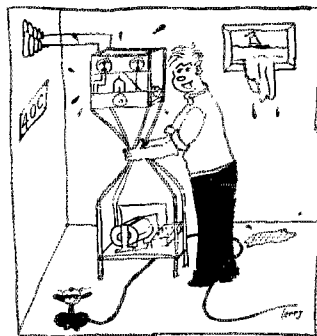

A GOOD CHECK

JACOBS ANTENNA SPREADER

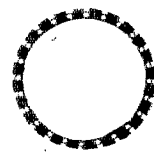

Made in both 5 in. and 7 in. diameter. Patented Sept. 8, 1925; Sept. 7, 1926

Effective Feb. 1st, 1929 price will be \$3.00 per dozen; \$4.50 for a half dozen

Charles F. Jacobs (W 2EM)
279 Park Place Brooklyn, N. Y.

HAM-ADS

Effective with the October, 1928, issue of *QST* the following changes were made in the rules of this department. The Ham-Ad rate is now 15c per word. The restriction which has limited use of this column to members of the American Radio Relay League is removed and advertising may be signed either by company name or by an individual. A special rate of 7c per word applies to advertising which is obviously non-commercial in nature and which is placed and signed by an individual member of the American Radio League. Please read carefully the following conditions under which advertising in these columns will be accepted.

(1) Advertising shall pertain to radio and shall be of nature of interest to radio amateurs or experimenters in their pursuit of the art.

(2) No display of any character will be accepted, nor can any special typographical arrangement, such as all or part capital letters be used which would tend to make one advertisement stand out from the others.

(3) The Ham-Ad rate is 15c per word, except as noted in paragraph (6) below.

(4) Remittance in full must accompany copy. No cash or contract discount or agency commission will be allowed.

(5) Closing date for Ham-Ads is the 25th of the second month preceding publication date.

(6) A special rate of 7c per word will apply to advertising which, in our judgment, is obviously non-commercial in nature and is placed and signed by a member of the American Radio Relay League. Thus, advertising of bona fide surplus equipment owned, used and for sale by an individual or apparatus offered for exchange or advertising inquiring for special equipment, if by a member of the American Radio Relay League takes the 7c rate. An attempt to deal in apparatus in quantity for profit, even if by an individual, is commercial and takes the 15c rate. Provisions of paragraphs (1), (2), (3) and (5) apply to all advertising in this column regardless of which rate may apply.

PLATE POWER for your set, the very heart of its performance. For quietness DX ability, life-long permanence, absolute dependability, lowest ultimate cost, no other plate source even approaches the achievement of an Edison steel-alkaline storage B battery. Built painstakingly every joint pure nickel, upset electrically welded. Genuine Edison Electrolyte. Our list describes complete batteries, construction parts, enameled aerial wire, silicon steel. Available immediately, filament and plate transformers for the new 865 rectifier, complete plate power units. Rectifier Engineering Service, radio W8ML, 4337 Rockwood Road, Cleveland, Ohio.

HAWLEY Edison element battery and parts standard for over five years. Look at our patent pending connector—no thin wire to drop off—contains 20 times more metal than regularly used. Heavy shock proof cells, fibre holders, etc. Everything for a rapid-fire "B" supply. Complete assembled 100 volt "B" \$10.00. Knock-down kits at still lower prices. Chargers that will charge in series up to 160 volts \$2.75 to \$4.00. Trickle B Charger for 90 to 150 volt "B" \$3.75. Special transmitter "B" batteries up to 6,000 milli-amp capacity, any voltage. Write for interesting literature, testimonials, etc. B. Hawley Smith, 840 Washington Ave., Danbury, Conn.

Used 203 A and 211 \$18; new 852 \$28; used \$20; used Western Electric 212A and 212D \$60 each; new Cunningham and RCA 210 \$6; new Cunningham and RCA 281 \$5; No 12 enameled aerial wire .90 per 100; Amateur Call Books \$35; 10" insulators \$.29; Freshman 375V. and two 7½V. center tapped transformers \$2.75; Robbins & Myers motor generator \$65; all types used Jewell meters \$4.75 each; three tube wired Aero coil set, best equipment \$20; REL 50 watt sockets \$1.50; signal corps 3/16" contact key \$.95; 210 Bradleystats \$1.75; new RCA 50 watters \$13.50, new 217A, 217B, \$23; new 90 volt Philco Storage Btry \$8; free list, lots of used and new apparatus. What have you for sale or trade? David L. Marks, 125 Madison Ave., Albany, N. Y.

OMNIGRAPHS. Teleplexes, transmitters, receivers, Vibroplexes, meters, 50 watters, S tubes, motor generators, dynamotors. Bought, sold, traded. Ryan Radio Co., Hannibal, Mo.

THORDARSON 650-volt power-filament transformer for 7½-wattors \$6.90. Aluminum square-foot 56c; Lead square-foot 86c. UX-210 7½ wattors \$6.25. UX-250's \$7.50. Potter 2000-volt test 1-mfd Condensers \$2.50; 2500-volt 1-mfd \$3.25; 2000-volt 2-mfd \$2.50. "Ham-List" 4c. James Curtis, 1109 Eighth Avenue, Fort Worth, Texas.

GENERAL Electric 24/1500 volt .233 ampere \$37.50 Shaft for external drive \$3.00 24/750 volt, 2 ampere \$27.50. Shafts \$3.00. Holtzer-Cabot 12/500 volt 35 watts \$20. Crocker-Wheeler 24,1500 volt 450 watts \$45. ½KW 500 cycle with exciters \$15.00 900 cycle 200 watts with complete transmitter \$30. Western Electric Helmets, Westinghouse 6-15 volt 500 watt generators, Special cartridge fuse 1500 volt 300 mills 50c dozen. Literature and fotos. Shipments any quantity anywhere. Henry Kienzle 501 East 84th Street New York.

FOR Sale—complete 50 watt transmitter, meters, panel, power supply, etc., \$50.00. W9JG, 3681 Rutger, St. Louis.

FIFTY cents and transportation paid for Murdock molded condensers 483 and 488 in good condition. Write before sending. Dept. of Physics, Univ. of Kansas, Lawrence, Kansas.

POWERFUL, shieldless, loop, antenna circuit \$1. Archer, 617 Decatur St., Brooklyn, N. Y.

HAMS look—two complete 7½ watt 80 meter transmitters complete with Aero coils, three Jewell meters and Cardwell condensers.—Two complete short wave receivers complete with Aero coils and Karas condensers.—Write for price and description. Harger & Blish Inc. 112 11th. Street, Des Moines, Iowa.

ENSALL Radio Laboratory receivers and Transmitters are of the most modern designs and are supplied to meet any particular requirements of the radio art. Transmitter designs for radiophone or C. W. Our long experience in the designing of special apparatus is your guarantee of quality and efficient apparatus. We also build to order any items desired. Literature on any apparatus forwarded on request. Ensall Radio Laboratory 1208 Grandview Ave., Warren, Ohio.

1929 Coils like August *QST* page 18 for 25 cents per turn. Antenna coils 20 cents per turn. W2VQ 388 North Grove St., East Orange, N. J.

CRYSTALS—First time offered to Hams. Easiest oscillators. Ground on Optical Laboratory Machinery with lens grinding precision. Unexcelled workmanship. 170 Band \$15.00 85 Band, \$18.00. Dr. Elmer J. White Optical Laboratory, W5AFG, Beaumont, Texas.

SELL QSTs from May 1922 to December 1928 inclusive. W3BSF.

QSL cards, 40c per 100, samples. Radcliffe, North Sacramento, Calif.

W8MG owned by E. F. Goodwin deceased selling out, great variety of equipment, 1 Kw. tube, ¼ Kw., ⅓ Kw. tubes, several fifties and MG sets. Also several receiving sets, etc. Write for lists. L. M. Augustus, 416 Florence St., Ypsilanti, Mich.

HAMS: Get our samples and prices on printed call cards made to order as you want them. W9APY Hinds, 19 S. Wells St., Chicago, Ill.

IN stock, Rectobulbs \$15, T81 Kenotrons 95c, \$2-\$8.56 meter Xcals \$17.50, 99.6% aluminum 70c sq. ft., no. 12 enameled wire 1c a ft., 25% off Thordarson, Jewell, Leach, Signal, Sangamo, REL, Ward Leonard, 35% on Tube and Flechtheim. The new Rectobulb \$10.00. Tubes repaired. Write for prices, Henry's Radio Shop, 9ARA, Butler, Mo.

SPECIAL made rectifier aluminum with small percentage copper, stand more amperage, last longer, square foot \$1.25. Lead \$1.00. Elemenis, holes punched with bolts and nuts, new kind 1"x4" 15c, 1"x6" 17c, pair prepaid. Best Silicon steel .014" cut to order 25-35c lb. Postage extra. Geo. Schulz, Calumet, Mich.

CHOKES—Dudlo-wound 50H, 150MA., unmounted—\$2.25, 30H, 100MA—\$1.50. B'Eliminator transformers 215V-7½V—\$1.75. Aerovox 5000 ohm Wire-wound gridleaks—50c. Pure rectifier elements and copper tubing inductance. Send for "Specials". Quick service. William Harrison, 35 Ft. Washington Ave. New York City.

SELLING out—write for list. W. E. Van Valkenburg, 1005 S. 17th St., Fort Dodge, Iowa.

USED parts bought, sold, exchanged. List. W9CKA, Corwith, Iowa.

QUARTZ crystals, guaranteed oscillators, 83 to 85 \$20.00; 165 to 170 \$15.00. Includes holder, easy to mount brass discs with lapped surfaces. Prepaid, cash with order. D. C. Akers, 181 Greenwood Ave., East Orange, N. J.

TRANSFORMERS with high voltage and two 7½ filament windings all center tapped—unmounted 200 watt size 1500 volts at \$7.50. Unmounted 100 watt size 1100 volts at \$6.00. 50 Henry 100 mill chokes at \$3.25. General Electric grid leaks in stock. W2CO, 210 Springdale Ave., East Orange, N. J.

3000 Volt 6000 Watt double commutator motor generator, 10 Hp. 3-phase drive \$685.00 complete. 3000 Volt 1000 Watt 1-phase drive \$225.00. 1500 Volt, 500 Watt 3-phase drive \$125.00. 1000 Volt 200 Watt Esco 1-phase drive \$75.00. 100 Volt 300 Watt, 1-phase drive \$75.00. 750 Volt 300 Watt \$65.00. 200 Watt \$45.00. 350 Volt, 50 Watt motor generators, \$18.50. 400 Volt 100 Watt generators \$3.50. Couplings \$1.75. Television Motors with controller \$7.00. Large stock filament generators. Queen City Electric Co., 1734 Grand Avenue, Chicago, Illinois.

3000 Volt 4000 Watt double commutator motor generator. Generator direct connected to 110-220 Volt, 60 cycle, 1-phase motor. Fields separately excited by another motor generator 1-phase drive. Complete ready for installation. \$550.00. James Smat, 1734 Grand Avenue, Chicago, Illinois.

QSL cards. Cartoons, Anything hams want. H. M. Selden, Cranesville, Pa.

BARGAIN flyer—power relay for use in your transmitter. Has tungsten steel contacts and will easily break 2000 volts. Can be kicked over by dry cell or storage battery. Eliminates danger of high voltage thru key and fb for remote control. A real buy. Order now at \$2.00 each, prepaid. Cash, check or money order. Mitchell Radio Co., 635 Waveland Ave., Chicago, Ill.

QSL cards, two colors, \$1.00 per hundred. Free samples. W8DTY, 257 Parker Ave., Buffalo, N. Y.

TRANSFORMERS, plate and filament supply transformers for 25-40-50-60 and 500 cycle supply, built to your order. High grade work, moderately priced. Nat G. Scott, New Albany, Miss.

MILLIAMMETERS, flush panel mounting, hand calibrated and accurate. Your choice 0-100, 0-300, or 0-400. \$1.25 Postpaid. Twenty-four hour service. New Price List mailed on request. G. F. Hall, 535 West Hortler St., Philadelphia, Pa.

FIVE disc Omnigraph with 12 discs. Best offer by February 15 gets it. Eber C. Hyam, R1, B 112, Rosewell, N. M.

SELL—Grebe CR9 and CR12 perfect condition; make offer. W8DD, Clarksville, Ark.

OMNIGRAPH, 15 dial in cabinet. Buzzer transformer, Western Electric phone, \$17.50. Two S tubes \$4.50 each. 600-0-600 transformer \$7.50. Filament transformer mounted, three 8 volt insulated windings \$5.00. 15 volt 35 ampere, unmounted \$4.50. Four tube receiver, one shield grid. New, very neat convenient designed. 15-200 meters in short steps, coils up to 800. \$50.00 with set new selected Cunningham tubes. 1929 Hartley transmitter, page 9 August QST. New, without meters, \$22.00. Hal Justice, W4TS, Canton, North Carolina.

SHORTWAVE receiver (2) two tube 15 to 210 meter, \$16.50 each; U. S. Army 5 water, \$1.50 each; Perryman UX216B \$2.00. H. MacLeod, Senford, N. Y.

MOTOR generator bargains. 750 Volt, 200 Watt, two commutator new General Electric motor generators direct connected to 110 Volt, 60 Cycle, 3500 R.P.M. single phase A.C. motors each \$45.00. 350 Volt, 150 Watt new General Electric motor generators direct connected to 110 Volt, 60 Cycle, 3500 R.P.M. single phase A.C. motors, with field resistance, each \$27.50. New ¼ Hp., General Electric and Westinghouse 110 Volt, 1750 R.P.M., A.C. motors \$8.75 each. New television variable speed motors for 110 Volt Alternating Current \$7.00 each. A limited number of each of the above items. Also many others to 3000 volts all sizes. Write us your needs. Electrical Surplus Company, 1911 Chicago Ave., Chicago, Ill.

QSLs, 100 two color \$1.00. Government \$1.90, radiograms, stationery. Samples. W9CCKA, Corwith Iowa.

NEW Morton Electric Company motor generator sets, 750V 250W, \$45.00. 1500V 500W 6 bearing wickoled unit, \$110. 110V 60 cycle motor drive. A Forbes, 4832 Rice St., Chicago, Ill.

275 volt generators, 3%. 600 volt \$18. 6 to 400 volt dynamotors \$15. 30 to 300 \$8. 500 cycle ½kw \$15. 200 watt \$10. R. Wood, 46-20 102nd St., Corona, N. Y.

WANTED: Navy standard receivers SE143, SE1230, SE1420, 1P500, 1P501, State manufacturer, condition and price. Trautwein, 17 Albany St., New York.

SPEAKERS. Rewound, Magnetized, Guaranteed, Fast Service, \$1.50 to \$2.50. Clark Brothers Radio Co., Albia, Iowa.

B ELIMINATORS, Repaired, New Condensers, Transformers, Chokes, Etc., Fast Service, \$2.00 to \$4.00. Clark Brothers Radio Co., Albia, Iowa.

TRANSFORMERS 250 watt 2000V unmounted \$8.00. 650V 7½-7½ \$5.50. 550V-5 \$4.00. Chokes 250 M.A. 30H \$7.50. 160 M.A. 30H \$5.00. 100 M.A. 30H \$2.00. Write for specifications and material lists. Radio Parts Sales Co., Orange, N. J.

ELECTRIC Specialty Company motor generator, motor type B1R-22, 110-220 volts, 60 cycles, 1700 RPM, 1 HP. Generator type L-28, volts 1000 amp. .5, compound wound, run about five hours. Cost \$175.—sell for \$100. J. L. Walsh, Missouri-Kansas-Texas RR Co., Dallas, Texas.

LITTELFUSES: the quickest-acting fuses in the world. See for yourself. Designed for protection of instruments, tubes and delicate equipment generally. Capacities: 1/32, 1-16, ¼, ½, 1, 2 amperes. 1" long x ½" dia. Each —15c; doz.—\$1.50; 100—\$10.00. Postpaid. Mounting blocks—20c. Discount to dealers. Littelfuse Labs., 1172 Wilson Ave., Chicago.

LARGE stock BC and SW sets and equipment don't need. Sell or trade for transmitting parts. C. C. Grayson, Box 825, Mexia, Tex.

SELL: 1KVA transformers 1100-2200-4400V each side CT, 110-220 primary. Used by Cornell Uni, at \$12.00. F.O.B. Det. F. G. Dawson, 5740 Woodrow Ave., Detroit, Mich.

IMAGINE an organization with over 4,000 clients scattered throughout the world, all radiowave dealers, builders, experimenters, hams. Over \$50,000.00 stock of high grade receiving and transmitting parts only no sets. Spend \$5,000.00 yearly on our own experimenting. Carry nothing until it passes our tests, 50c brings prepaid over four pounds catalog, circuits, data, etc. Weekly data (more than all radio magazines together) —20 weeks—\$1.00, 52 weeks—\$2.50. Sample "Over The Soldering Iron," 32 page experimenter's magazine—25c. Full trade discounts to licensed hams and radiowave builders. We carry approved items advertised in radio. Kladag Radio Laboratories, Established 1920, Kent, Ohio.

SELL—Hundred watt panel transmitter (three Cardwells, three Westons); plate and filament transformers; rotary converter for 110 d.c.; series resistance for 240 d.c. Lieut. Wenstrom, West Point, N. Y.

FOR sale: Emerson 500 volt 110 a.c. motor generator and field regulator like new, \$36.00. F. W. Steffen, Hartley, Iowa.

FOR sale: I new DeForest H. R. 1000 volt rectifier tube, \$10.00. Frank Dixon, Knoxville, Iowa.

WANTED—Good used 204A tube, also one S-tube. State price. Harry Lecler, Hiawatha, Kansas.

WANTED: Grebe CR-18 A1 condition. Karl Black, 12 Brewster St., Rockland, Maine.

DUBLIER, .004 transmitting condensers wanted. Radio, 150 West 22nd St., New York

WANTED: One Burned Out General Electric RCA 750 watt Shield Grid Tube, C. F. Wm. Bates, 9410 St. Catherine Ave., Cleveland, Ohio.

CRYSTALS: Carefully selected for maximum output. Your complete satisfaction guaranteed, 35 water band, \$17.50. Blanks \$4.00. W9DRD, Hollister, Edwardsville, Kansas.

WANTED: UP1658, 150-watt, 60-cycle, 110-10.5 volt RCA filament-transformers. State condition and best price. F. E. Handy, 1711 Park St., Hartford, Conn.

Massachusetts Radio and Telegraph School

18 Boylston Street, Boston

Send for Catalogue

Tel. Hancock 8184 Established 1905

Q R A SECTION

50c straight with copy in following address form only:

WIMK

A.R.R.L. Headquarters

R. B. Parmenter, Chief Op. "rp."

The following calls and personal sines belong to members of the A.R.R.L. Headquarters gang:

W1AL H. P. Westman "ws."
 W1BDI F. E. Handy "fh."
 W1BHW-W1EH K. B. Warner "kb."
 W1BMM-W1FL G. D. Meserve "dm."
 W1BUD A. L. Budlong "bud."
 W1CEI-W1SZ J. J. Lamb "jm."
 W1ES A. A. Hebert "ah."
 W1KP F. C. Beekley "beek."
 W1PX C. G. Kenefiek "ck."
 W1SZ-W1BIZ C. C. Rodimon "rod."
 L. R. Huber "ou."
 R. A. Hull "rah."

W1CTR—Daniel J. Giro, 56 Lafayette St., Portland, Maine.

W2CY—W. Thurston Weatherbee, Sunrise Trail, East Moriches, Long Island, N. Y.

W5VW—Wilmer Allison, 1502 West Ave., Austin, Texas.

W7WD—F. A. Wright, P. O. Box 611, Omak, Wash.

W8FC—W. Knight Hamilton, 26 Bay St., Potsdam, N. Y.

OZ2GJ—K. L. Elliott, 92 West St., Feilding, New Zealand.

TRANSFORMERS, CHOKES COILS

*of all descriptions made
to your specifications.*

The crying need of the radio constructor and amateur for *efficient* coils, chokes, and transformers for either transmitter or receiver construction, is filled by the "Most Efficient" Power equipment manufactured by I. R. NELSON CO.

The new and radical core design developed by this company gives the small power transformers and coils all the efficiency inherent in large electrical construction work. Write in your wants. We will be glad to quote you. You will be surprised at the quality received for your investment. Prompt delivery on all orders.

I. R. NELSON COMPANY
Bond Street Newark, N. J.

Never before at this Sacrifice Price!

Radiotron Model UV-204. 250 Watt Transmitting Tubes



Normal Plate Voltage 2000 V. Filament Voltage 11 V.
 The operating characteristics of this 250 watt tube is similar to that of the UV-204-A. Radiotron with the exception that the filament current is higher. Aside from this modification the tube is interchangeable.

At our price you should carry a few of these tubes if only as spares.

These genuine R.C.A. UV-204 Transmitting Tubes are first grade, brand new, and packed in original factory crates.

Terms:—20% with order, balance C. O. D.

Extra Special \$52.00 ea.

Net Price
\$127.50 ea.

AMERICAN SALES CO., 19-21 Warren St., NEW YORK

HOW MANY TIMES

This year will you miss schedules while you turn scrubwoman, or wait on a burned out kenotron? How many volts are you losing in that maze of jars? Hundreds. No need for it. The mercury arc is on the job every minute of the year—you don't have to baby it, leave that to the YLs. No filament to burn out, full wave. Regulation? Just a 15 volt drop, and what's that in a couple thousand? Get an arc and operate.

RECTIFIER ENGINEERING SERVICE, 4837 Rockwood Road, WSMU, Cleveland, Ohio

To Our Readers who are not A. R. R. L. members

Wouldn't you like to become a member of the American Radio Relay League? We need you in this big organization of radio amateurs, the only amateur association that does things. From your reading of *QST* you have gained a knowledge of the nature of the League and what it does, and you have read its purposes as set forth on page 6 of every issue. We should like to have you become a full-fledged member and add your strength to ours in the things we are undertaking for Amateur Radio. You will have the membership edition of *QST* delivered at your door each month. A convenient application form is printed below—clip it out and mail it today.

A bona fide interest in radio is the only essential qualification for membership.

American Radio Relay League,
Hartford, Conn., U. S. A.

I hereby apply for membership in the American Radio Relay League, and enclose \$2.50 (\$3 in foreign countries) in payment of one year's dues. This entitles me to receive *QST* for the same period. Please begin my subscription with the issue. Mail my Certificate of Membership and send *QST* to the following name and address.

Do you know a friend who is also interested in Amateur Radio, whose name you might give us so we may send him a sample copy of *QST*?

Thanks

FOR YOUR CONVENIENCE QST'S INDEX OF ADVERTISERS IN THIS ISSUE

Aero Products, Inc.	86, 3rd cover
Aerovox Wireless Corp.	84
Allen-Bradley Company	84
Allied Radio Corp.	79
American Sales Company	87, 89, 93
American Transformer Co.	82
Arcturus Radio Company	80
Auricula, Inc., Ad.	78
A. R. R. L. Emblem	87
A. R. R. L. Handbook	2nd cover
A. R. R. L. Membership Blank	94
A. R. R. L. Recommendation Blank	89
Barawik Company	82, 86, 95
Barros & Co., M.	85
Benson-Allen Company	88
Burgess Battery Company	4th cover
Candler System Co.	88
Cardwell Mfg. Corp., Allen	8
Central Radio Labs.	79
Chicago Radio Apparatus Co.	90
Chlorostat Mfg. Co.	76
Coating Glass Works	75
Cosmo Electrical School	25
Cordley Radio Corp.	77
Cummingham, Inc., E. T.	56
Dodge, C. K.	90
Douvan Electric Mfg. Co.	82
Dублион Condenser Corp.	58
Eastern Radio Institute	86
Electric Specialty Co.	85
Elkon, Inc.	73
Formica Insulation Co.	71
Frost, Inc., Herbert H.	76
General Radio Company	4
Grehen, E.	89
Gulf Radio School	87
Hardwick, Field, Inc.	74
International Correspondence Schools	72
Jacobs, Chas. F.	90
Jewell Electrical Instrument Co.	60
Johnson, E. F.	83
Kahn, Morton B.	85
Leeds Radio Company	81
Leonis Publishing Co.	70
Mass. Radio & Telegraph School	92
National Company, Inc.	84
National Radio Tube Co.	88
Neison Company, I. R.	93
Parent Electric Co.	90
Peerless Products Co.	87
Photo Electric Devices, Inc.	87
Potter Company, The	86
QST Binder	88
QST Bound Volume	30
Radio Amateur Call Book, Inc.	74
Radio Corporation of America	1
Radio Engineering	83
Radio Engineering Labs.	89
Radio Equipment Co.	89
Radio Institute of America	70
Raytheon Mfg. Co.	83
Reetifier Engineering Service	93
Rooney, John T.	86
Sanramo Electric Co.	67
Scientific Radio Service	89
Scott, J. T.	89
Shortwave & Television Laboratories	88
Silver-Marchall, Inc.	59
Teleplex Company	82
Thordarson Electric Mfg. Co.	63
Van Nostrand Company, D.	57
Vibroplex Company	72
Ward Leonard Electric Co.	83
Western Radio Mfg. Co.	85
Western Electrical Instrument Corp.	69
Wireless Specialty Apparatus Co.	61
X-L Radio Laboratories	84
Taxley Mfg. Company	74

Barawik - the Old Reliable

RADIO SERVICE

**Official Distributors
for Aero Short
Wave Products**

**Send Your Orders Here for
Quick Service for the New
1929 Coils, Transmitters,
Monitor, Etc.**



THE NEW YEAR with the new amateur bands, means turning over a new leaf for most amateurs. Barawik is all ready to serve you with the latest Aero coils and kits covering the new 20, 40 and 80-meter bands, also the new powerful 1929 500-watt Aero Transmitter, new Aero transmitter coils and kits, the new S. W. Converter and the indispensable new Aero Listening Monitor, a necessity for every "ham."

Barawik was the first radio supply house to cater to amateurs and thousands of Q.R.S. readers have found that they can get quicker service, better attention and lower prices here than anywhere else. No order is too small or too large for us.

Realizing that many amateurs will be greatly inconvenienced because of the new bands, Barawik has arranged with Aero Products, Inc., to supply the new 1929 equipment at once. Order the items shown by Aero Products, Inc. on the following two pages direct from us, using the coupon below and enclosing remittances as per prices quoted—or have them sent C.O.D., as you prefer. Some of the items quoted are net, others carrying a discount that will be passed along to you, so if your remittance is more than the net price, we will refund you the difference.

Mail your order now by regular post or air mail and bring your short wave receiver and transmitter up to date. Rush shipments will be made by us to you.

The Barawik Co.

112-B Canal Sta., Chicago, Ill.

-----ORDER COUPON FOR AERO PRODUCTS:-----

BARAWIK CO. 112-B Canal Sta., Chicago, Ill.

Dear Sirs:

Please send me the following new 1929 Aero Products as advertised:

Code No.	Name of Article	Price
.....
.....
.....
.....

- Enclosed is remittance for \$-----.
- Send new Barawik Catalog showing complete radio and short wave line.

Your Name

St. and No.

City State.....

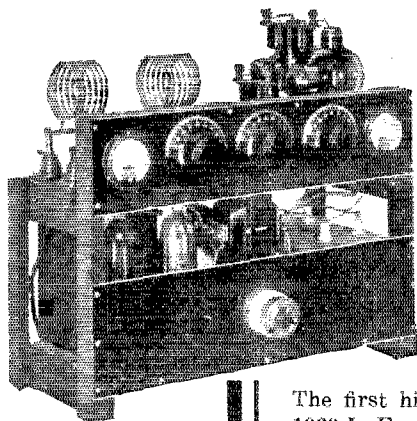

You Have Been Waiting For It!

Aero Kit 52—New High Power Xmitter and 150 Watt Amplifier

Operation on 10-20-40-80-100M Bands!

ROLL CALL OF STATIONS

Don't take our word for it. Hear it any nite from 8-12:30 p.m., C.S.T. and be convinced. Following list of stations were worked while developing this Xmitter. Audibility records were from R6 to R9. Ask them!

w6asj	w7hp	w6ajm
w4aen	w3aaj	w6exh
w6aak	w6dij	ve-51s
wndev	w6bzy	w8bfa
w5pp	w3apo	w8afe
nz-fr-5	w7wl	w2apc
w8dxe	w4tpj	kdv5
w2bpc	w4ca	w5bdx
w8afe	w9cmx	w1awd
w1tx	w31h	w3ase
w2kj	w1bal	w6cqq
w6boa	w9ees	w1cr
w7qw	w4akq	w7ts
w2hmc	w5rd	w2bhr
w7aej	w1no	w8bts
w1bks	w2bz	w8ahc
w8dbm	w6lx	w6zb
w7tu	w1bb1	w1art
w1ack	w8aic	w9ext
w8li	w7alc	w7aet
w4afw	w2bpc	w9bhx
w8bwp	ve-2hr	w5axw
w2bff	w8ccm	w8bbs
w1crw	w1cej	w5abs
w8alu	w1cw	w1auk
w1bal	w1blo	w6dfr
w7uk	w2avc	w1lf
w2blx	w7ch	w5bb1
w8mi	w5azn	w1ua
w2hob	w8dde	w7aoo
w6ei	w5ex	w2fo
w1bcw	w2dw	w2avq
w3ql	w2af	w2bkb
w3crb	w8bda	w8elm
w2biv	w9evo	w3hh
w5abs	w5tx	w1ca
w4si	w1ca	w2bsc
w1ccx	w6avj	w2axx
w4oa	w5uf	w5qx
w2aun	w6erb	

The first high power amplifier to use the UX-860 screen grid tubes. 1929 In Every Detail. 150 Watts of Pure D. C. Signals With a Stability Which Has Caused Favorable Remarks Everywhere. Flexibility that Fills Every Ham Need.

You can use either two UX-852 tubes when using this new Aero Kit No. 52 as a single unit for a transmitter; or two UX-860 (screen grid) tubes, employed when using with Aero Kit No. 55; or as a 150-watt amplifier in any master oscillator combination.

For those desiring a master oscillator system, this unit works with a high degree of efficiency as an amplifier. With two screen grid UX-860 power tubes in this arrangement, it requires no neutralizing. Hook this unit on your present oscillator, converting it into a 1929 job, with ample power for ham use.

It may be operated as an amplifier with Aero's low power No. 55 Radiophone Xmitter, and a complete C. W. and phone set can be had, making a combination 150-watt high-power master oscillator, approached only by commercial broadcast stations.

Last, but not least—as a Hartley oscillator using two UX-852 tubes, this unit performs in true 1929 fashion.

Power supply delivers 2000 volts at 250 M.A. Employs two of the R.C.A.'s newest rectifiers, UX-217C. Due to the construction of the UX-217C, unusually high voltage may be applied safely to them.

Kit No. 52—including the power supply, but not including tubes. List Price \$259.00

LISTEN IN!—HEAR IT ANY NITE FM 8.00-12:30 P. M.—C.S.T. Kit No. 53—150-Watt Transmitter and amplifier, using two 860 or 852 tubes, less power supply and tubes, List Price \$114.00

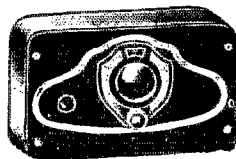

New Aero 1929 Listening Monitor

Now a real necessity for every "Ham" Are You Working in the Dark?

The Aero Listening Monitor Box virtually turns a flood-light on your transmitter that you might accurately know your station and not be a cripple depending on the reports of fellow hams. Is your note pure D.C.? Do you think it is or do you KNOW from your own observation? BE WISE! BE SURE! and BE SAFE! Secure an Aero Monitor and be able to check your own note. Take a tip from Q.S.T. and don't drive your Lizzie by Watching the Ammeter, but know the road and keep the supervisor away from your shack.

The Aero Listening Monitor is a completely shielded unit, including filament and F supply and operates with a UX-199 type of tube. It is contained in a golden-brown metal cabinet, 9 inches long by 5½ inches high, by 2½ inches deep, crockle finish. It employs a stable circuit and delivers a signal intensity of about R-4 or 5. The battery supply is thoroughly shielded from the R.F.; hence no trouble from this source, thereby giving the operator the opportunity to secure a reliable piece of apparatus which also incorporates automatic filament control. Shp. wt., about 2½ lbs.

List Price—Model M-29—including Dry Batteries But No Tube \$15.00

4611 E. Ravenswood Ave., Dept. 329 **AERO PRODUCTS** INCORPORATED Chicago, Illinois U. S. A.

AERO COIL

THE NEW
SHORT WAVE

1929 AERO COILS

Greater Selectivity—Low Losses

The new bands are narrower—To cut Q.R.M. now, only the *most selective receivers* can be used. Selectivity and low losses in the tuning circuits are synonymous. Almost every condenser has negligible losses, *but where can you find even an approach to the low losses of Aero coils?*

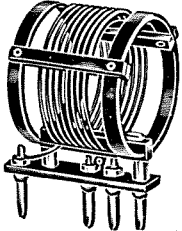

In keeping with past performance, the adoption of the new bands fits Aero Products ready with new coil kits. The same low loss construction, with consequent selectivity even more important than ever before, is still adopted, but the new coils spread the new bands over the major portion of the dial, while still leaving sufficient space on each end to assure against lap-over. Designed especially for the new amateur bands, they are the most efficient coils which can be used. A new and better space-wound primary is also provided, and the same base, with the isolated grid terminal, is employed.

AMATEUR SPECIAL KIT NO. LWT 13
covering new 20, 40 and 80 meter bands with .00003 condenser, *including plug-in base with new design of adjustable space-wound primary \$12.50

ADDITIONAL COIL INT-Ao
range 8.2 to 12.6 meters \$4.00

BROKEN KIT PRICES

AMATEUR SPECIAL COIL No. INT-A1 range 19.1 to 27.6 meters, \$4.00.	AMATEUR SPECIAL COIL No. INT-A3 range 61.6 to 90.2 meters, \$4.00.
AMATEUR SPECIAL COIL No. INT-A2 range 31.4 to 48.6 meters, \$4.00.	PLUG-IN BASE with new space-wound primary Type LWT 100-P, \$3.00.
*Aero AE 912 Variable Condenser, .00003, each \$1.50	

THE NEW AERO HIGH POWER TRANSMITTING COILS

designed to be as closely as possible in accord with "1929 practice" as outlined in recent issues of Q.S.T. For the first time "plug-in" coils can be used for high power. Newly designed plugs will carry up to 15 amperes with safety. Heavy aluminum rod is used for the completely self-supporting coil. A new material with asbestos backing, superior in electrical characteristics to glass, without its fragility, is used for the spacing bar. Porcelain insulators assure the user against leakage, and electro-static shields and other points of design previously limited in use to variable condensers, have been incorporated in these coils.

Coils are designed for use with 440 MMFD Condenser.

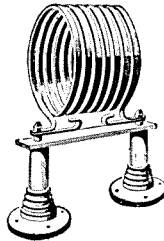

SPECIAL FEATURES

1. Heavy aluminum strip provides for carrying 500 watts safely
2. Electrostatic shields keep strain out of insulation—
3. Newly developed insulating material—has losses below glass
4. Plug-in feature permits rapid shifting between bands
5. Porcelain bases reduce leakage
6. Highly polished to reduce losses
7. Air space between conductor and insulation
8. Newly designed plug carries heavy currents without trouble

PRICES

Kits of Two Coils, complete with plug-in mounts: \$15.00
TEL 24K, 16.5 to 45 Meters \$15.00
TEL 48K, 39 to 88 Meters

SINGLE COILS

24C—16.5 to 45 Meters \$7.50
48C—39 to 88 Meters \$7.50
Plug-in mountings only, per pair \$3.50
Plugs only, with nuts, per pair \$2.00

Get the Big Green Book—Mail This Coupon Now

Aero Products, Inc., 4611 E. Ravenswood Ave.
Dept. 311, Chicago, Ill.
Please send me a copy of your 25c Aero Green Book showing 64 pages of newest modern circuits for short wave and broadcast receivers, transmitters, coils and kits.

Name
St. & No.
City State..... (311)

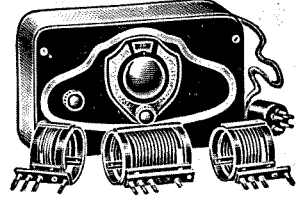

Aero Factory Built Short Wave Converter

No short wave converter on the market is comparable with the new Aero 1929 model. Its advent sounds a new era in short wave converters. Many factory-built items of this character now being sold are giving trouble particularly on the A.C. models, because there has been found no general adaption of converters to the A.C. filter on the broadcast sets. The new Aero Converters eliminate all these difficulties.

Model A: One of the outstanding troubles on Short Wave A.C. Converters is motorboating. This is caused by the fact that the converter is plugged into a set with an efficient A.C. filter for the broadcast receiver, but when the converter is plugged into it, the A.C. filter system in the broadcast set is inefficient for the oscillating circuit in the short wave converter. This trouble is overcome in the New Aero Factory-Built Short Wave Converter by an auxiliary filter system which is operated from a small dial on the back of A.C. Converters. Simply turn the knob until proper adjustment is secured and leave it at that adjustment.

Model D: In order to open up the region of short waves for those already possessing a battery-operated radio set. We have developed a highly efficient unit used to convert or adapt your present D.C. receiver for operation on the low waves by simply removing the detector tube and plugging in the socket a tube base connected to the Converter by means of a cable, thus completely connecting this unit to your present radio set and power supply in one operation.

Model A and Model D Converters are in small metal cabinets—5½ inches high, 9 inches long and 2½ inches wide. The metal cabinets, as well as acting as a shield, become an object of beauty. They are finished in a beautiful golden brown, crackle-finish. Ship, wt., about 3 lbs. **Model A for A.C. Sets...** \$25.00
Model D for D.C. Sets... \$25.00



New 1929 Aero Grid Choke No. C-250

A Compact Choke Coil for suppressing high frequency oscillations in transmitting vacuum tubes. Price \$2.00.

Aero Transmitting Choke No. C-248

For circuits where continuous current never exceeds 100 mills. May be used safely on intermittent current up to 200 mills. Price \$1.50

Choke No. C-249
11 to 200 meters, 150-200 mills continuous current, or 300 mills intermittent current, Price \$1.50



"Ask any Radio Engineer"

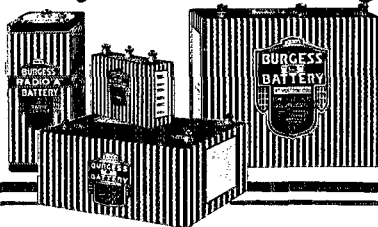

BURGESS BATTERY COMPANY

MADISON,

WISCONSIN



"Ask any Radio Engineer"

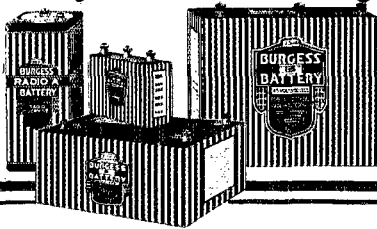

BURGESS BATTERY COMPANY

MADISON,

WISCONSIN
